

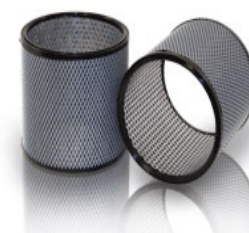

Graco Application for Auto Tier1

Jan 2015



PROVEN QUALITY. LEADING TECHNOLOGY.

Material Suppliers



Material Supplier	Market	Application	Main Chemistry
Sika	Interior/Exterior; Glass; Sunroof	Bonding	2K PU, PUR, Butyl
Dow Corning	Auto lamp; auto electronics; Lubrication	Sealing/Bonding Potting Lubrication	1K/2K Silicone Grease
Henkel	Auto lamp; Auto electronics; Engine; Waterproof film, Hot melt molding	Sealing/Bonding Potting Molding	2K PU, PUR, Silicone, PA, Epoxy, Butyl
Lord	Auto electronics (LSR)	Bonding Potting	2K epoxy, MMA, PU, Silicone
Threebond	Engine/Transmission Gasketing	Sealing/Bonding	Silicone
Wacker	Auto electronics	Sealing/Bonding Potting	1K/2K Silicone, 2K PU, Epoxy
HuiTian	Auto lamp	Sealing	Silicone
Guibao	Auto lamp	Sealing	2K Silicone
Bostik	Interior/Exterior; Weather stripping	Sealing/Bonding	Butyl, PU, PUR
Araldite	Interior/Exterior; Auto electronics	Sealing/Bonding	1K/2K Epoxy



Automotive Parts

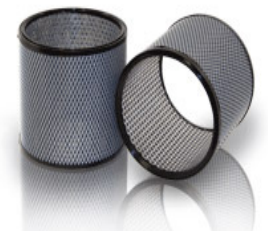

PROVEN QUALITY. LEADING TECHNOLOGY.

Automotive Parts



Component	Application	Material	Graco Solution
Head Lamp	Sealing	1K Silicone	Supply System + PCF
		PUR/Butyl	TOF
		2K Silicone	HFR



Automotive Parts



Component	Application	Material	Graco Solution
Interior/Exterior	Bonding	PUR/Butyl	TOF + Swirl gun
		2K Epoxy/PU/MMA	HFR / PR70



Automotive Parts



Component	Application	Material	Graco Solution
Sunroof / Glass	Sealing	1K PU/Silicone	Supply System + PGM
		Butyl	TOF



Automotive Parts



Component	Application	Material	Graco Solution
Waterproof film	Bonding	PSA (Foam) Butyl	TOF + Regulator

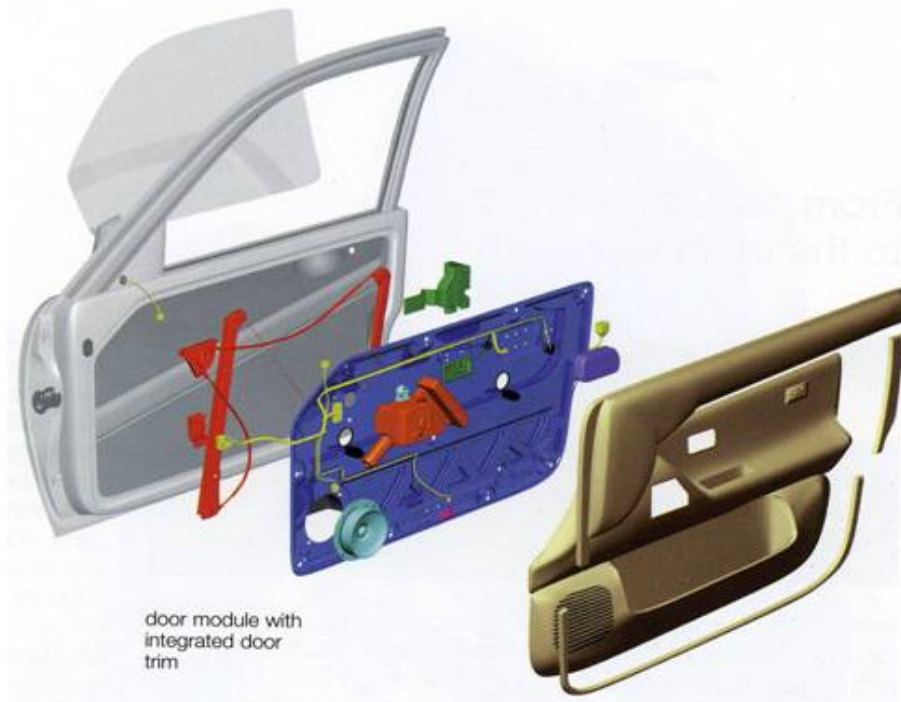

Automotive Parts



Component	Application	Material	Graco Solution
Engine	Gasketing	1k Silicone	Supply System + PCF



Automotive Parts



Component	Application	Material	Graco Solution
Weather stripping	Sealing	1K Butyl (Cold)	Supply System + PCF
		PSA (Foam)	TOF + Regulator

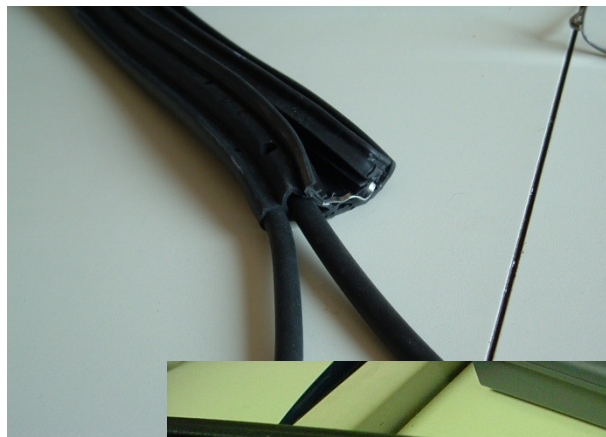

Automotive Parts



Component	Application	Material	Graco Solution
Airbag	Lamination	2K Silicone	HFR
	Sealing	2K Silicone	HFR



Automotive Parts



Component	Application	Material	Graco Solution
Filter	Cap Molding	Hotmelt/PA	TOF/InvisiPac
	End cap Bonding	2k Epoxy/PU	HFR/PR70



Auto Grease application



Component	Application	Material	Graco Solution
Axle	Sealing	1K Silicone	Supply System + PCF



Automotive Parts



Component	Application	Material	Graco Solution
Tire	Sealant Coating	Butyl	TOF + PGM

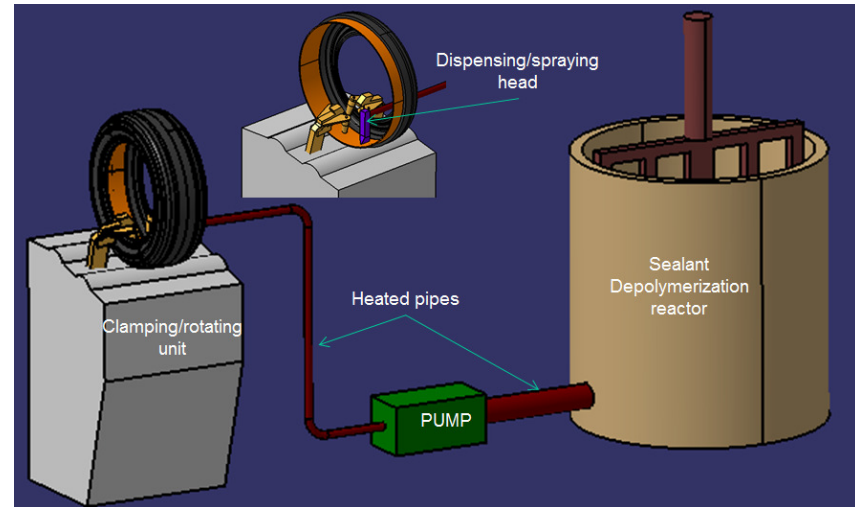

Automotive Parts - Electronics

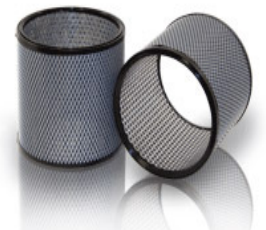
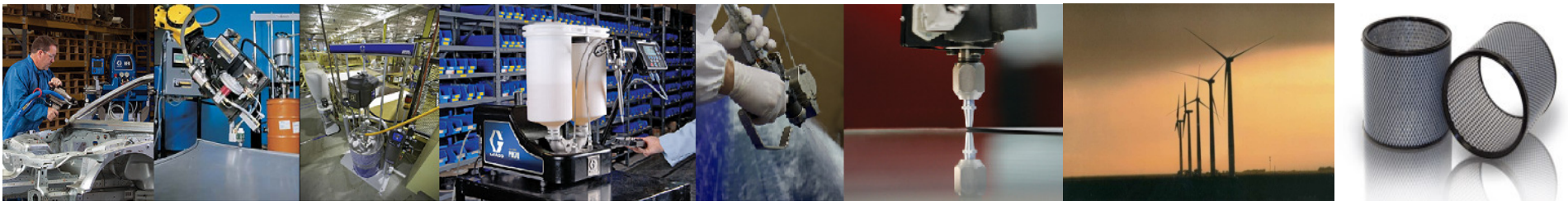

Automotive Electronics



Component	Application	Material	Graco Solution
PCB, Cable, Coil, Sensor, Connector, Micro Motor	Low Pressure Molding	PA	InvisiPac

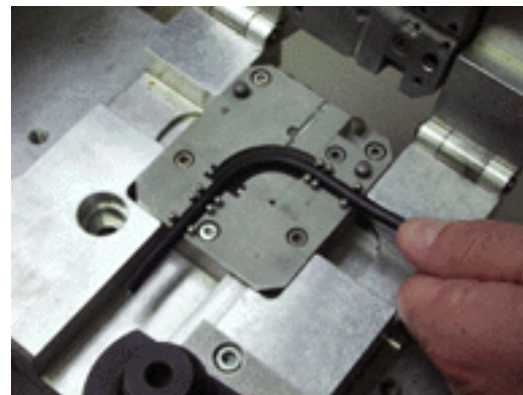
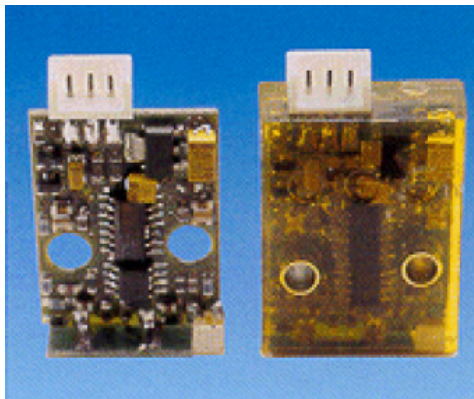
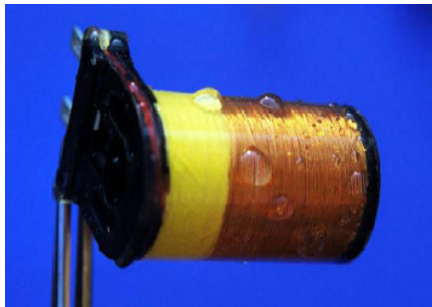

Automotive Electronics



Component	Application	Material	Graco Solution
ECU	Gasketing	Hotmelt 1k Silicone	TOF + PGM Supply + PCF
	Potting	2k Silicone/PU/ Epoxy	PR70/PD44
	Heat Conduct	Heat Conduction Grease	Supply + PCF

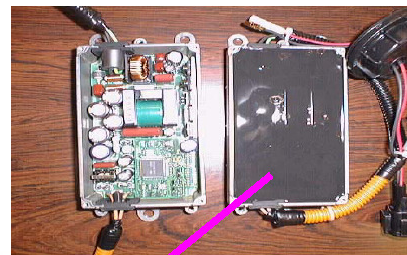
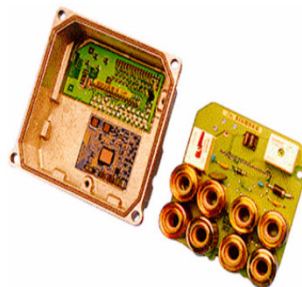
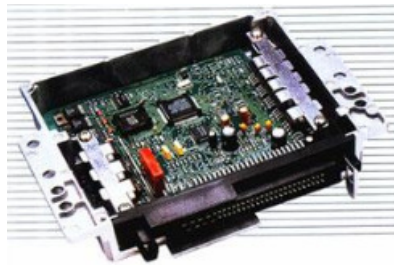

Automotive Electronics



Component	Application	Material	Graco Solution
Wiring & Cable & Connector	Sealing	1k Silicone 2k Silicone	PR70/PD44
	Potting	2k Silicone/Epoxy/PU	PR70/PD44

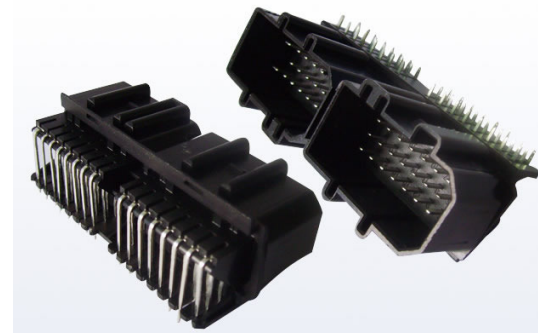
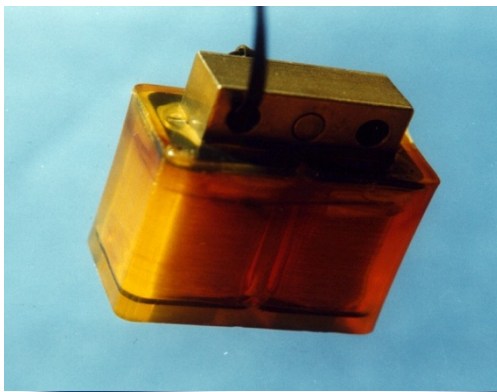
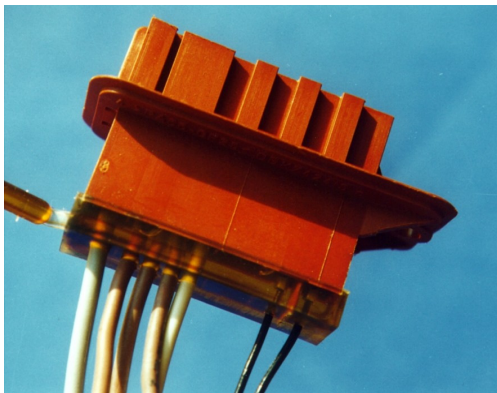

www.dzsc.com

PROVEN QUALITY. LEADING TECHNOLOGY.

Automotive Electronics



Component	Application	Material	Graco Solution
Sensor	Potting	2k Silicone/Epoxy/PU	PR70/PD44
	Molding	PA	InvisiPac

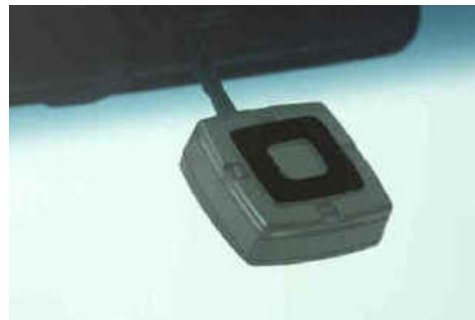

Automotive Electronics



Component	Application	Material	Graco Solution
Micro Motor	Potting	2K Silicone/Epoxy/PU	PD44/PR70
	Bonding	2K Epoxy/MMA	PD44/PR70

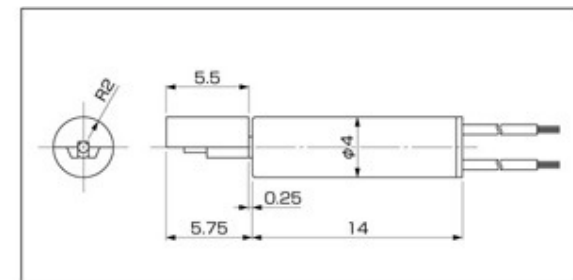
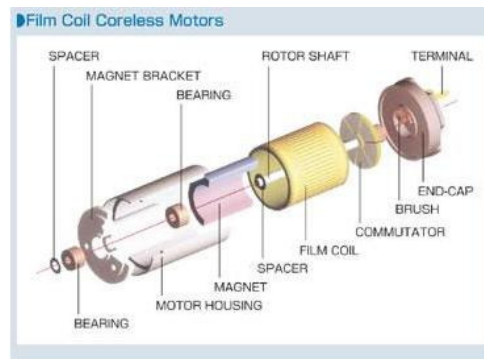
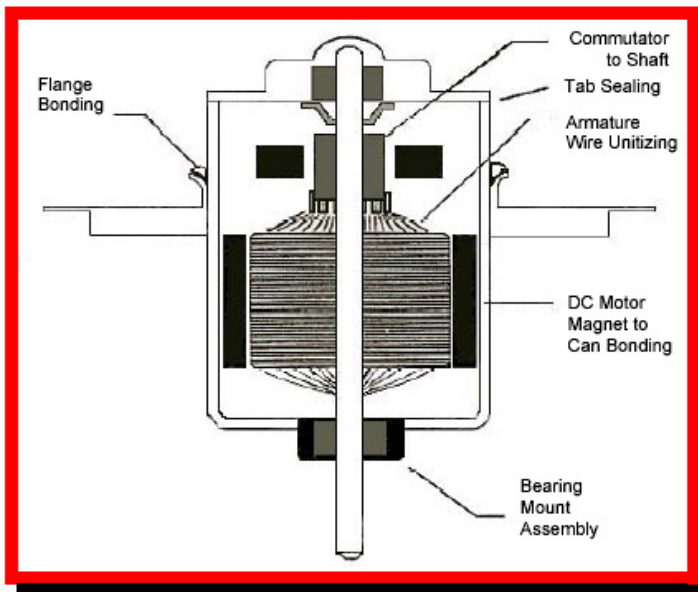

Automotive Electronics



Component	Application	Material	Graco Solution
Loudspeaker	Sealing	1K/2K Silicone/PU	Supply + PCF PD44/PR70
	Bonding	PUR/2K PU	TOF/PD44/PR70



流意汽车 www.lishe.com



流意汽车 www.lishe.com



Automotive Electronics



Component	Application	Material	Graco Solution
Auto Electric Appliance	Sealing	1K/2K Silicone/PU	Supply + PCF PD44/PR70
	Bonding	PUR/2K PU	TOF/PD44/PR70

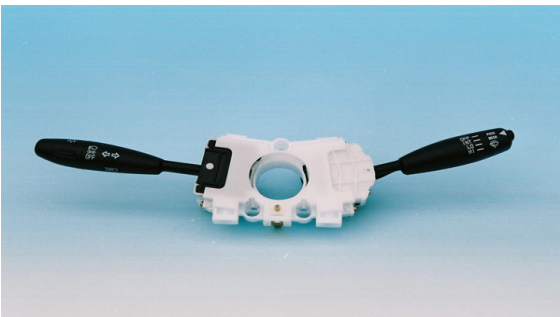
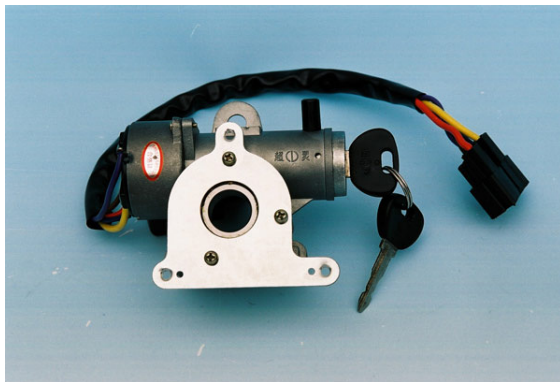

Auto Grease application



Component	Application	Material	Graco Solution
Engine, transmission, Axle, Micro Motor, Brake system, Door lock, Handles, Seats, Sunroof Shaft.....	Lubrication	Grease / lubricants	Supply System

