



**Global supplier of stainless steel, fluid handling packages and components that minimize dirt in paint utilizing:**

- **Smooth bore designs**
- **Cavity free features**
- **Certified silicone and contaminant free systems**

**2019 Components Catalog**

# Every paint shop organization has a common enemy...

## DIRT IN PAINT!

From the most sophisticated painting operation to the most basic paint spray set up, our customers spend significant amounts time and money for filtration: Air supply, parts washers, paint pumping systems, robots, coating machines, spray applicators, even skilled personnel to operate the processes and equipment. Yet many paint shop managers still spend several hours a day battling with "dirt in paint". So, what is it? Where does it come from? And why is it there?

In many cases, some part of these problems were initiated when the paint delivery or circulation system was first installed. Poor choices were made in the selection of devices used in the piping system- ball valves, fittings and connectors, flow control devices, hose connectors and hose or tubing to name a few. **The key features essential in these components are smooth bore, cavity free, low shear and silicone or contaminant free.**

Modern coating materials including resins, binders, effects pigments and fillers can "pack out" or settle in cracks, thread pockets and crevices. These agglomerations grow and eventually break free of their attachment point or cavity area, creating an expensive paint repair. Over the life of a system, this will generate increasing numbers of defects, and degrade the color and appearance finished products. It is necessary to specify and control the installation of equipment into the paint delivery or circulation system, focusing on meeting the smooth bore, cavity free, low shear and silicone or contaminant free component requirements as expansions, alterations or repairs are done to the piping or delivery system.

Let's consider a simple and real-world example: If one spray defect is created per hour in a Paint Circulation System in a mid-size automobile paint shop that operates 2 shifts per day, there are 16 repairs done per day, an automotive body panel repair or reprocess is estimated at approximately \$200 each, so \$3200 per day is generated in repair expense related to dirt in paint from the paint circulation system, over 250 days that adds up to \$800,000/year! This is a tremendous justification for setting up and enforcing specific performance requirements for components to be used in the paint delivery or paint circulation system for all customers. .

**We strongly encourage all of our customers to insist on having control of the components to be used in the construction, alteration, expansion or repair of the piping and hosing of the paint delivery or circulation system in their plants!**

## Where does Hosco fit into this initiative?

The most important consideration is that 80% of the fluid connections in a paint delivery or paint circulation system are in the paint station drops that feed the paint application equipment, and this is the place to focus on for improving quality and throughput of the paint operation. Without the emphasis on smooth bore, cavity free, low shear and silicone or contaminant free requirements, automatic or manual paint station drops are the main source where dirt pockets can be found. A typical manual or automatic paint drop station is shown here to illustrate the thousands of places in a typical paint delivery system where paint can settle out and create "dirt in paint". Using Hosco smooth bore, cavity free, low shear, and silicone and contaminant free certified components, available in both inch and metric sizes for operations around the world will insure optimal results, delivering clean paint to an efficient operation.

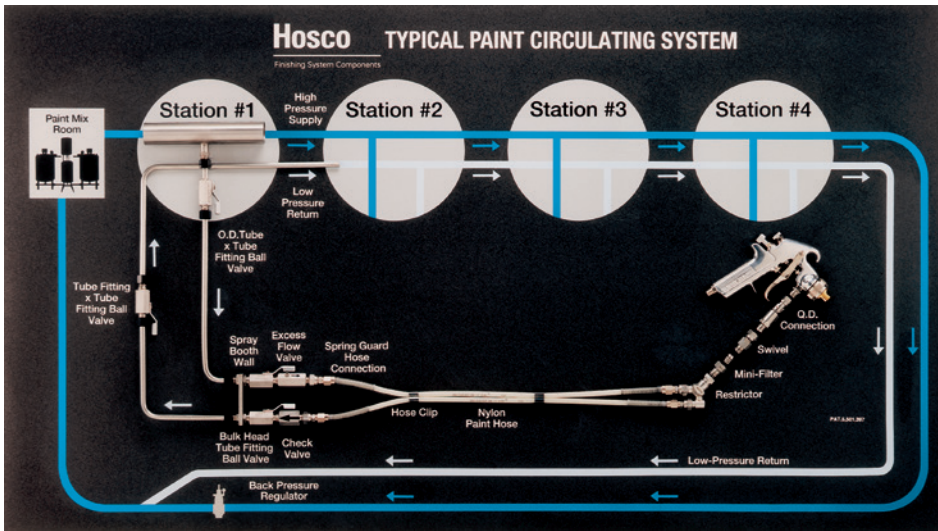

## Typical Manual Spray Station

Manual stations total drop connection detail:

# of Colors	# of Stations	# of Drops
6 Prime	2	12 Prime
12 B/C	6	72 B/C
4 C/C	6	24 C/C
22 Materials	14	108 Total

108 drops x 14 Connection points/drop = 1,512 total connections!

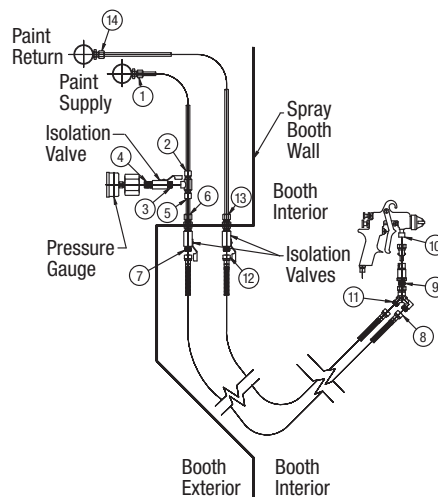

## Typical Automated Spray Station

Automated stations total drop connection detail:

# of Colors	# of Stations	# of Drops
6 Prime	2	36 Prime
12 B/C	16	192 B/C
4 C/C	16	64 C/C
22 Materials	38	292 Total

292 drops x 20 Connection points/drop = 5,840 total connections!

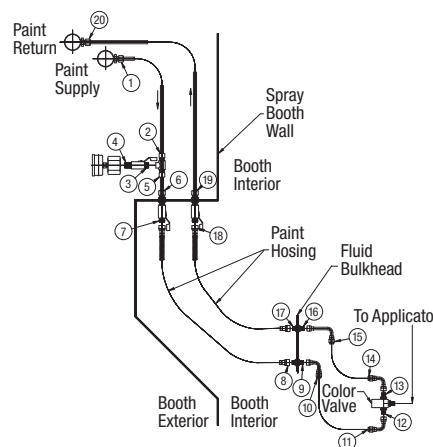

As you can see there are a total of 7,352 connection points in the drop stations plus an estimated 1,800 in the paint mix room and piping racks. This is an illustration of the thousands of places that can generate "dirt in paint" from the paint delivery or paint circulation system in a mid sized Automotive Paint Shop. **Hosco strongly encourages our customers to adopt controls on the components to be used in the paint delivery or circulation system and mandating Smooth Bore, Cavity Free, Low Shear, and Certified Silicone and Contaminant Free components only!** This mandate includes Ball Valves, Fittings, Tees and Adapters, Flow Control devices, Pressure Regulation, Hose Connectors and Hose or Tubing components.

## Table of Contents

- 5 Fluid Quick Disconnects
- 6 Mini-Filter, Tank Strainers
- 7 Applicator Flow Restrictors
- 8 Tube Assemblies, Strain Reliefs
- 9 Stainless Steel Hose Connectors
- 13 Non-Conductive Nylon Hose Connectors
- 14 Monoline Coaxial Hose Assemblies
- 15 Nylon Hose and Tubing
- 16 Coaxial Paint Hose
- 17 Static Wire Air Hose, Accessories
- 18 Fluoropolymer Tubing, FEP/PTFE/PFA/FLM
- 20 Stainless Steel Jacketed Hose/Fire Hyde
- 21 SSBV and HBV Ball Valves
- 25 H-Valves and 3 Way Ball Valves
- 26 HRS Manifold Paint Stations
- 28 Live Swivels and Check Valves
- 29 Circulation Adapters
- 30 SST Fittings and Adapters
- 36 SST Tees and Gauges
- 37 Compression Fittings - Fractional Inch
- 40 Compression Fittings - Metric
- 44 PreFis Connection Systems
- 47 Bundled Tubing and Hose Management
- 49 Maintenance Tools
- 50 Shroud Cleaner Upgrades
- 54 Imagineering
- 55 Global Reach
- 55 Common Paint Systems Connection Description

## Hosco's Technology and Performance Promise:

**Our smooth bore, cavity free, low shear and silicone and contaminant free focus and promise will pave the way for dirt free paint delivery to the spray applicators.**

**Here are five product area examples:**



### Encapsulated Ball Valves

All Hosco 316 series patented encapsulated ball valves have no cavities around the ball so there is no place for paint to collect and dry. They also include PTFE seats and an adjustable retainer ring. All ball valves are rated for 1000 PSI (70 BAR) working pressure.

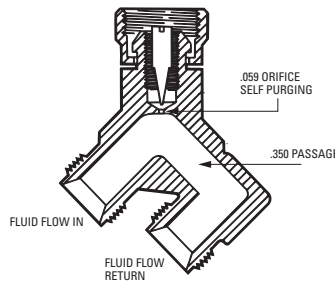

### Flow Control Restrictors

Hosco flow control restrictors are available in stainless steel or lightweight composite materials. They are compact, low cost, lightweight, tamper proof, replace gun regulators, and have a smooth flow .350 I. D. recirculating passage with no pressure loss.



### "Low Shear" Cavity Free Connection Fittings

All Hosco connection fittings feature its new "Low Shear" design that incorporates a taper-to-taper connection, which eliminates the blunt end or shelf surface found in conventional fittings. The design enhances Hosco's smooth bore, cavity free product line helping metallic paint finishes retain their color, luster and quality while reducing system pressure loss, speeding installation procedures and furthering overall safety.

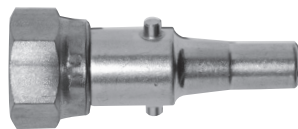

### Quick Disconnect "No-spit" Fittings

Hosco paint quick disconnects work precisely with Hosco stems to eliminate the accumulation of paint and sludge that forms during everyday use of paint quick disconnects sets. The fittings eliminate the need for frequent solvent flushing or washing, cleaning away accumulated waste to prevent paint pits.

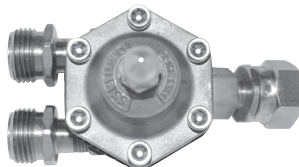

### Restrictor/Regulator

The Hosco HHR-6 restrictor/regulator incorporates a restrictor on a regulated paint outlet and then permits adjusting it to the desired flow rate to the spray gun. This helps attain maximum accuracy and repeatability while maintaining spray gun control even in the extremely low range. This restrictor/regulator is well suited for painting large structures with their inherent elevation changes from top to bottom such as aircraft, trucks and buses or for electrostatic air spray/HVLP painting applications.



# Quick Disconnects

## QD Bodies

Male Straight



Part Number	T
SSQD-4	1/4 NPS
SSQD-4B	1/4 BSP
SSQD-6	3/8 NPS
SSQD-6B	3/8 BSP

Male Tapered



Part Number	T
SSQD-2T	1/8 NPT
SSQD-4T	1/4 NPT
SSQD-6T	3/8 NPT

Hosco paint quick disconnects provide quick and easy color or material changing to the applicator in a paint or adhesive dispensing or spraying operation. The QD/Stem set minimizes the need for frequent solvent flushing or washing to clean away accumulated waste and to prevent paint spits that can cause defects in the product surface being sprayed. Hosco SSQD and SS-Stem combinations are the most used SST set throughout the world!

## Feature and Benefits

### 304/316 SST Construction

- Compatible with all coatings and adhesive materials known
- SST construction provides long service life
- Rebuildable with repair kits.

### 300 PSI Working Pressure

- Compatible with a wide range of applicators and application pressure

### Precision Design/No Spit Operation

- Eliminates coating build up in the QD seal area
- Reduces cleaning intervals
- Rebuildable with spare parts kits

### Unique Manufacturing Processes

- MIM molded stem reduces size and weight, Bayonet QD body is the most compact in the world
- Large flow passageways minimize shear and coating degradation and subsequent pressure or flowrate losses

## Stems

Open Flow Female Straight



Part Number	T
SS-STEM-4	1/4 NPS
SS-STEM-4B	1/4 BSP
SS-STEM-6	3/8 NPS
SS-STEM-6B	3/8 BSP

Checked Flow Female Straight



Part Number	T
SS-STEM-6CV	3/8 NPS
SS-STEM-6CVB	3/8 BSP

## Tools

Dummy Stem to hang QD Bodies and Hoses from.



Part Number	T
CSD-6	3/8 NPS
CSD-6B	3/8 BSP

## Spare Parts

We offer 2 different kits with replacement parts.

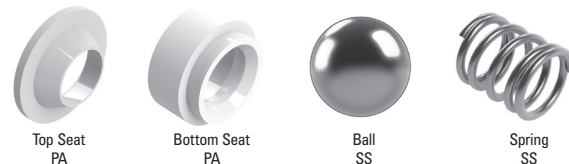

Part Number	Description
QDRK-6	Kit consists of 2 seats, 1 ball, and 1 spring
QDSK-6	Kit consists of 2 seats.



# Mini-Filter and Tank Strainer Filter

## Mini-Filter Assembly

Female Straight x Male Straight

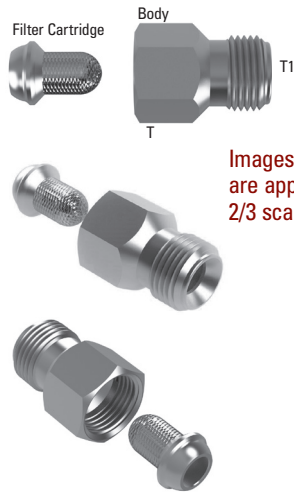

Images are approx. 2/3 scale

Part Number	T (F)	T1 (M)	SIZE
MF-6-40	3/8 NPS	3/8 NPS	40 MESH/350 MICRON
MF-6B-40B	3/8 BSP	3/8 BSP	40 MESH/350 MICRON
MF-6-70	3/8 NPS	3/8 NPS	70 MESH/200 MICRON
MF-6B-70B	3/8 BSP	3/8 BSP	70 MESH/200 MICRON
MF-6-100	3/8 NPS	3/8 NPS	100 MESH/149 MICRON
MF-6B-100B	3/8 BSP	3/8 BSP	100 MESH/149 MICRON
MF-6-150	3/8 NPS	3/8 NPS	150MESH/100 MICRON
MF-6B-150B	3/8 BSP	3/8 BSP	150MESH/100 MICRON
MF-6-200	3/8 NPS	3/8 NPS	200 MESH/74 MICRON
MF-6B-200B	3/8 BSP	3/8 BSP	200 MESH/74 MICRON
MF-6-325	3/8 NPS	3/8 NPS	325 MESH/44 MICRON
MF-6B-325B	3/8 BSP	3/8 BSP	325 MESH/44 MICRON
MF-6-500	3/8 NPS	3/8 NPS	500 MESH/25 MICRON
MF-6B-500B	3/8 BSP	3/8 BSP	500 MESH/25 MICRON

### Filter Cartridge Only

Part Number	SIZE
MFC-40	40 MESH/350 MICRON
MFC-70	70 MESH/200 MICRON
MFC-100	100 MESH/149 MICRON
MFC-150	150MESH/100 MICRON
MFC-200	200 MESH/74 MICRON
MFC-325	325 MESH/44 MICRON
MFC-500	500 MESH/25 MICRON

### Mini-Filter Body Only Female Straight x Male Straight

Part Number	T (F)	T1 (M)
MFB	3/8 NPS	3/8 NPS
MFB-B	3/8 BSP	3/8 BSP

**Note:** We recommend users consult their material suppliers for proper selection of filtration size.

Hosco Mini-Filters and Station Filters incorporate SST wire mesh filter elements to provide absolute filtration at the specified wire mesh or micron size. There are 7 mesh or micron sizes available in the Mini-Filter products and 2 sizes available in the Station filter. The finest mesh size is 500 mesh or 25 micron and the coarsest mesh size is 40 mesh or 350 micron. In general, solvents and clear fluids would use the finer mesh and the solid color paints, metallic paints or highly filled or high solids paints will use the coarser mesh elements. The Mini-Filters have a compact design, and can be installed in line to eliminate "dirt in paint". The Station Filter is a good solution to providing filtration in a Pressure Pot or 5-gallon pail pumping set up and some unique "in-line" filtration in larger fluid piping systems.

## Feature and Benefits

### SST construction throughout

- Materials compatible with all coatings or adhesives
- Long life

### Low Shear design

- Large flow passageways minimize shear and coating degradation and subsequent pressure or flowrate losses

### Cavity Free & Smooth Bore design

- To minimize material pack out or "dirt in paint" and provide easy to clean and flush components

### 2500 PSI Working pressure\*

- Compatible with a wide range of applicators and application pressure

### Compact design

- Mini-filter allows spray operators to maneuver the spraygun into small areas or tight spaces much easier than alternatives

## Tank Strainer Filter

Female Straight x Male Straight

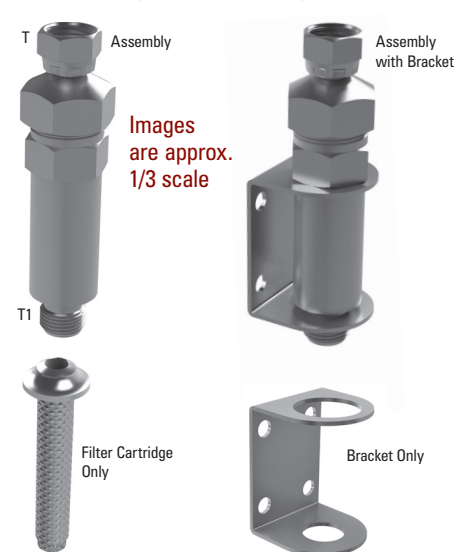

Images are approx. 1/3 scale

### Assembly

Part Number	T (F)	T1 (M)	SIZE
TSF-6-100	3/8 NPS	3/8 NPS	100 MESH
TSF-6-60	3/8 NPS	3/8 NPS	60 MESH

### Assembly with Bracket

Part Number	T (F)	T1 (M)	SIZE
TSF-6-100-BRKT	3/8 NPS	3/8 NPS	100 MESH
TSF-6-60-BRKT	3/8 NPS	3/8 NPS	60 MESH

### Filter Cartridge

Part Number	SIZE
TSF-100	100 MESH
TSF-100-10PK	100 MESH
TSF-60	60 MESH
TSF-60-10PK	60 MESH

### Bracket

Part Number
TSF-BRKT



# Restrictors

## Externally Adjustable

Female Straight x Male Straight

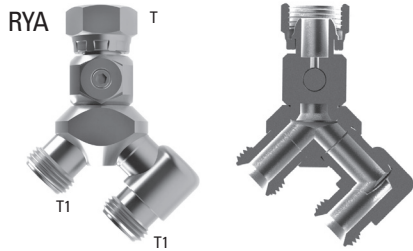
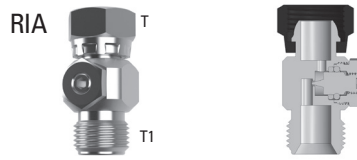

Part Number	T(F)	T1(M)
RIA-6	3/8 NPS	3/8 NPS
RIA-6B	3/8 BSP	3/8 BSP

Part Number	T(F)	T1(M)
RYA-6	3/8 NPS	3/8 NPS
RYA-6B	3/8 BSP	3/8 BSP
RYA-4	3/8 NPS	1/4 NPS
RYA-4B	3/8 BSP	1/4 BSP

## Internally Adjustable

Female Straight x Male Straight

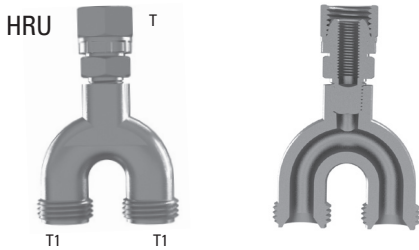
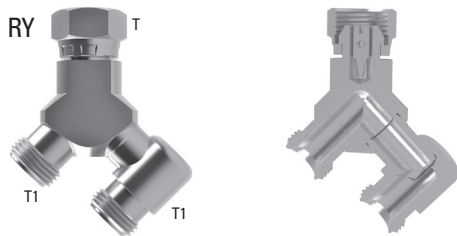

Part Number	T(F)	T1(M)
RY-4	3/8 NPS	1/4 NPS
RY-4B	3/8 BSP	1/4 BSP
RY-6	3/8 NPS	3/8 NPS
RY-6B	3/8 BSP	3/8 BSP

Part Number	T(F)	T1(M)
RIL-6	3/8 NPS	3/8 NPS
RIL-6B	3/8 BSP	3/8 BSP

Female Straight x Male Tapered

Part Number	T(F)	T1(M)
RIL-2T	3/8 NPS	1/8 NPT

Part Number	T(F)	T1(M)
HRU-6	3/8 NPS	3/8 NPS
HRU-6B	3/8 BSP	3/8 BSP

## Tool for Internally Adjustable Restrictor Adjusting Block

Female Straight x Male Straight

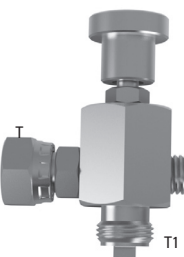

Part Number	T(F)	T1(M)
RAB-6	3/8 NPS	3/8 NPS
RAB-6B	3/8 BSP	3/8 BSP

Hosco Stainless Steel Restrictors provide reliable, long life fluid flow control to an applicator. The family of products consists of recirculating and non-circulating versions that can be internally set (tamperproof) or externally adjusted even while dispensing. The long tapered needle design of the restrictors provide fine flowrate adjustments from complete shut off to over 1000 cc/min (depending on pressure and viscosity). Settings are repeatable from restrictor to restrictor station so set up is relatively easy. The internally set styles may require the RAB-6 Tool to provide initial set point adjustment while the restrictor is "on line". The externally adjusted versions require an allen wrench for adjustment which is included with the restrictor.

## Feature and Benefits

### SST Construction

- Long life
- Compatible with all coatings and adhesive materials known

### Compact Design

- Allows spray operators to maneuver the spraygun into small areas or tight spaces much easier than alternatives
- Much smaller and lighter than regulator based alternatives

### Multiple Configurations

- Tamperproof or externally adjustable versions
- Circulating or non-circulating versions
- In-line or 45 degree hose connection versions on circulating versions to keep hoses away from the product being coated

### Low Shear Design

- 0.350" smooth bore passageways in circulating versions protect the coating from excessive shear during operation and minimize pressure loss of the recirculating function

### Highest ROI Flow Control Device

- Hosco Restrictors are generally 1/3 the cost of older regulator versions, and last easily 10X longer between service events or replacement



# Tube Assemblies

Male Straight x Female Straight x 3-3/4" long



Part Number	T(M)	T1(F)
GE-600	3/8 NPS	3/8 NPS
GE-600B	3/8 BSP	3/8 BSP

Male Straight x Female Straight 30° x 3-3/4" long



Part Number	T(M)	T1(F)
GE-630	3/8 NPS	3/8 NPS
GE-630B	3/8 BSP	3/8 BSP

Male Straight x Female Straight 90°

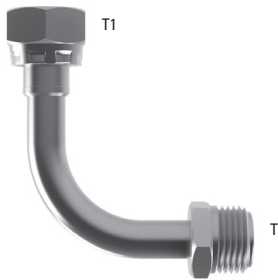

Part Number	T(M)	T1(F)
SSL4-4SN-90	1/4 NPS	1/4 NPS
SSL6-4SN-90	3/8 NPS	1/4 NPS
SSL6-6SN-90	3/8 NPS	3/8 NPS
SSL6B-6SNB-90	3/8 BSP	3/8 BSP

Female Straight x Female Straight 90°

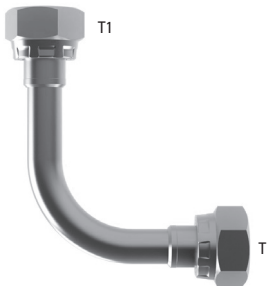

Part Number	T(F)	T1(F)
SSL6SN-4SN-90	3/8 NPS	1/4 NPS
SSL6SN-6SN-90	3/8 NPS	3/8 NPS
SSL6SNB-6SNB-90	3/8 BSP	3/8 BSP
SSL4SN-4SN-90	1/4 NPS	1/4 NPS

Female Straight x Hose Connection

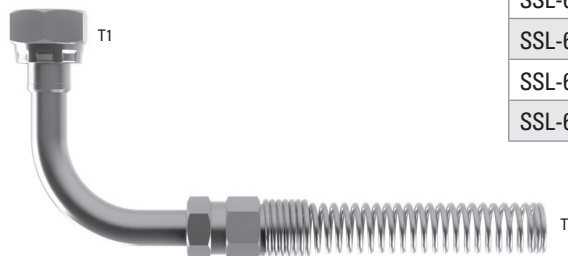

Part Number	T(F)	T1(F)
SSL-6SN-6X8-SG	3/8 NPS	6MMX8MM
SSL-6SN-7X9.6-SG	3/8 NPS	7MMX9.6MM
SSL-6SN-7X10-SG	3/8 NPS	7MMX10MM
SSL-6SN-9X12-SG	3/8 NPS	9MMX12MM

Hosco tube assemblies are designed to provide strain relief and routing control. In addition, the smooth radius sweeps eliminate coating damage and shear, while controlling restriction to keep piping systems in balance. These tube assemblies are typically constructed of 316 SST seamless tubing in 1/4", 5/16", and 3/8" OD tube sizes, and are also available in metric sizes 8mm to 18mm. The tube assemblies are provided typically with 1/4" and 3/8" male or female swivel nut connection points in NPS or BSPP (PF), but also can be provided in JIC, compression, NPT or BSPT (PT), or open tube stub configurations.

## Feature and Benefits

### Multiple Configurations

- In-line, 45, 60 or 90 degree inlet/outlet(s) versions
- 1/4", 5/16", 3/8", plus multiple metric OD tube sizes available
- NPT/BSPT(PT), NPS/BSPP(PF), Compression, JIC, and Tube Stub connection points

### SST Construction

- 304L/316 materials compatible with all coatings or adhesives
- Long life

### Unique Manufacturing Processes

- Unique processing provides chemical free passivation and absolutely clean product for installation
- Nickel braze process assures full 316 SST construction and absolute compatibility to even De-ionized water systems

### Cavity Free & Smooth Bore Design

- To minimize material pack out or "dirt in paint" and provide easy to clean and flush components

### Low Shear Design

- Large flow passageways minimize shear and coating degradation and subsequent pressure or flowrate losses





# SST Hose Fittings

Hosco SST Hose Connectors are designed to provide connections of hose and tubing using the robust and industry leading Hosco barb and nut style retention system.

These connectors significantly exceed the performance of other style connectors and provide the highest level of safe and reliable connections found today for use in flammable or hazardous fluid handling.

The SST connectors are available in both spring-guard versions to provide support for the hose or tube at the connector when strain relief is needed, or non-springguard version for a static or stationary connection point.

The SST family of hose connectors are available in common sizes of fractional inch or metric hose connection ends, and in straight or compact 90 degree configurations. The connection point is available in two common ends- NPT/BSPT(PT) male in 1/8", 1/4", and 3/8" sizes, or NPS/BSPP(PF) female swivel nut in 1/4" and 3/8" sizes.

## Feature and Benefits

### SST Materials of Construction

- Suitable for most paints, coatings or solvents in use
- Wide range of chemical compatibility
- Reusable, and long service life

### Multiple Sizes, Two Configurations

- Provides one common style of connector for fractional inch and metric hoses or tubes with straight or 90 degree styles

### Robust Designs

- Mechanical retention of hose or tube is best available technology to insure safety and trouble free operation
- NPS/BSPP(PF) connector design is intended for multiple or frequent "make & break" connections for servicing or replacement of components

### Patented Technology

- Connectors can be installed with the lowest wrench forces in the industry, which is important as dispense or paint stations are made more compact and recessed minimizing installers ability to exert high wrench forces.



## Nylon Tubing

OD	ID	Part No.	Hose Connector Size							
			No Springguard		With Springguard		No Springguard		With Springguard	
			1/4" NPS(F)	3/8" NPS(F)	1/4" NPS(F)	3/8" NPS(F)	1/4" NPS(F)	3/8" NPS(F)	1/4" NPS(F)	3/8" NPS(F)
			BSP(F) Add "-B" Suffix to P/N (Example 1438-SG-B)							
3/16" (4.8MM)	.138" (3.5MM)	NHA-0302	1814-SS-187	1838-SS-187	1814-SG-187	1838-SG-287	1814-SS-90-187	1838-SS-90-187	1814-SG-90-187	1838-SG-90-187
1/4" (6.35MM)	.180" (4.6MM)	NHA-0403	31614-SS-256	31638-SS-256	31614-SG-256	31638-SG-256	31614-SS-90-256	31638-SS-90-256	31614-SG-90-256	31638-SG-90-256
1/4" (6.35MM)	.170" (4.31MM)	NHA-250170	17014-SS-256	17038-SS-256	17014-SG-256	17038-SG-256	17014-SS-90-256	17038-SS-90-256	17014-SG-90-256	17038-SG-90-256
5/16" (8MM)	.236" (6MM)	NHA-0504 NHA-8X6	6X8-14-SS	6X8-38-SS	6X8-14-SG	6X8-38-SG	6X8-14-SS-90	6X8-38-SS-90	6X8-14-SG-90	6X8-38-SG-90
3/8" (9.6MM)	.275" (7MM)	NHA-375275	0714-SS	0738-SS	0714-SG	0738-SG	0714-SS-90	0738-SS-90	0714-SG-90	0738-SG-90
1/2" (12.7MM)	3/8" (9.5MM)	NHA-0806	3814-SS	3838-SS	3814-SG	3838-SG	3814-SS-90	3838-SS-90	3814-SG-90	3838-SG-90
.236" (6MM)	.157" (4MM)	NHA-6X4	4X6-14-SS	4X6-38-SS	4X6-14-SG	4X6-38-SG	4X6-14-SS-90	4X6-38-SS-90	4X6-14-SG-90	4X6-38-SG-90
.354" (9MM)	.236" (6MM)	NHA-9X6	6X9-14-SS	6X9-38-SS	6X9-14-SG	6X9-38-SG	6X9-14-SS-90	6X9-38-SS-90	6X9-14-SG-90	6X9-38-SG-90
.394" (10MM)	.275" (7MM)	NHA-10X7	7X10-14-SS	7X10-38-SS	7X10-14-SG	7X10-38-SG	7X10-14-SS-90	7X10-38-SS-90	7X10-14-SG-90	7X10-38-SG-90
.394" (10MM)	5/16" (8MM)	NHA-10X8	8X10-14-SS	8X10-38-SS	8X10-14-SG	8X10-38-SG	8X10-14-SS-90	8X10-38-SS-90	8X10-14-SG-90	8X10-38-SG-90
.472" (12MM)	.354" (9MM)	NHA-12X9	9X12-14-SS	9X12-38-SS	9X12-14-SG	9X12-38-SG	9X12-14-SS-90	9X12-38-SS-90	9X12-14-SG-90	9X12-38-SG-90
.472" (12MM)	.394" (10MM)	NHA-12X10	10X12-14-SS	10X12-38-SS	10X12-14-SG	10X12-38-SG	10X12-14-SS-90	10X12-38-SS-90	10X12-14-SG-90	10X12-38-SG-90



# SST Hose Fittings continued



## Nylon Hose

OD	ID	Part No.	Hose Connector Size							
			No Springguard		With Springguard		No Springguard		With Springguard	
			1/4" NPS(F)	3/8" NPS(F)	1/4" NPS(F)	3/8" NPS(F)	1/4" NPS(F)	3/8" NPS(F)	1/4" NPS(F)	3/8" NPS(F)
			BSP(F) Add "-B" Suffix to P/N (Example 1438-SG-B)							
.225" (5.7MM)	1/8" (3.2MM)	NP-2	1814-SS	1838-SS	1814-SG	1838-SG	1814-SS-90	1838-SS-90	1814-SG-90	1838-SG-90
.264" (6.7MM)	3/16" (4.8MM)	NP-3	31614-SS	31638-SS	31614-SG	31638-SG	31614-SS-90	31638-SS-90	31614-SG-90	31638-SG-90
.350" (8.9MM)	1/4" (6.35MM)	NP-4	1414-SS	1438-SS	1414-SG	1438-SG	1414-SS-90	1438-SS-90	1414-SG-90	1438-SG-90
.350" (8.9MM)	1/4" (6.35MM)	NP-4TL	1414-SS	1438-SS	1414-SG	1438-SG	1414-SS-90	1438-SS-90	1414-SG-90	1438-SG-90
.425" (10.8MM)	3/16" (8MM)	NP-5	51614-SS	51638-SS	51614-SG	51638-SG	51614-SS-90	51638-SS-90	51614-SG-90	51638-SG-90
.500" (12.7MM)	3/8" (9.5MM)	NP-6	3814-SS	3838-SS	3814-SG	3838-SG	3814-SS-90	3838-SS-90	3814-SG-90	3838-SG-90

## Coaxial Paint Hose

OD	ID	Part No.	Hose Connector Size							
			No Springguard		With Springguard		No Springguard		With Springguard	
			1/4" NPS(F)	3/8" NPS(F)	1/4" NPS(F)	3/8" NPS(F)	1/4" NPS(F)	3/8" NPS(F)	1/4" NPS(F)	3/8" NPS(F)
			BSP(F) Add "-B" Suffix to P/N (Example 1438-SG-B)							
.350" (8.9MM)	1/4" (6.35MM)	CPH-4	1414-SS	1438-SS	1414-SG	1438-SG	1414-SS-90	1438-SS-90	1414-SG-90	1438-SG-90
.350" (8.9MM)	1/4" (6.35MM)	CPH-4TL	1414-SS	1438-SS	1414-SG	1438-SG	1414-SS-90	1438-SS-90	1414-SG-90	1438-SG-90
.425" (10.5MM)	5/16" (8MM)	CPH-5	51614-SS	51638-SS	51614-SG	51638-SG	51614-SS-90	51638-SS-90	51614-SG-90	51638-SG-90
.500" (12.7MM)	3/8" (9.5MM)	CPH-6	3814-SS	3838-SS	3814-SG	3838-SG	3814-SS-90	3838-SS-90	3814-SG-90	3838-SG-90

## Fluoropolymer Tubing

OD	ID	Part No.	Hose Connector Size							
			No Springguard		With Springguard		No Springguard		With Springguard	
			1/4" NPS(F)	3/8" NPS(F)	1/4" NPS(F)	3/8" NPS(F)	1/4" NPS(F)	3/8" NPS(F)	1/4" NPS(F)	3/8" NPS(F)
			BSP(F) Add "-B" Suffix to P/N (Example 1438-SG-T-B)							
3/16" (4.76MM)	1/8" (3.18MM)	FEP-0302	1814-SS-187	1838-SS-187	1814-SG-187	1838-SG-187	1814-SS-90-187	1838-SS-90-187	1814-SG-90-187	1838-SG-90-187
1/4" (6.35MM)	1/8" (3.18MM)	FEP-0402	1814-SS-T	1838-SS-T	1814-SG-T	1838-SG-T	1814-SS-90-T	1838-SS-90-T	1814-SG-90-T	1838-SG-90-T
1/4" (6.35MM)	.170" (4.31MM)	FEP-250170	17014-SS-256	17038-SS-256	17014-SG-256	17038-SG-256	17014-SS-90-256	17038-SS-90-256	17014-SG-90-256	17038-SG-90-256
1/4" (6.35MM)	3/16" (4.76MM)	FEP-0403	31614-SS-256	31638-SS-256	31614-SG-256	31638-SG-256	31614-SS-90-256	31638-SS-90-256	31614-SG-90-256	31638-SG-90-256
5/16" (7.94MM)	3/16" (4.76MM)	FEP-0503	31614-SS-T	31638-SS-T	31614-SG-T	31638-SG-T	31614-SS-90-T	31638-SS-90-T	31614-SG-90-T	31638-SG-90-T
5/16" (7.94MM)	1/4" (6.35MM)	FEP-0504	1414-SS-312	1438-SS-312	1414-SG-312	1438-SG-312	1414-SS-90-312	1438-SS-90-312	1414-SG-90-312	1438-SG-90-312
3/8" (9.53MM)	1/4" (6.35MM)	FEP-0604	1414-SS-T	1438-SS-T	1414-SG-T	1438-SG-T	1414-SS-90-T	1438-SS-90-T	1414-SG-90-T	1438-SG-90-T
1/2" (12.7MM)	3/8" (9.53MM)	FEP-0806	3814-SS-T	3838-SS-T	3814-SG-T	3838-SG-T	3814-SS-90-T	3838-SS-90-T	3814-SG-90-T	3838-SG-90-T
.196" (5MM)	.118" (3MM)	FEPM-5X3	3X5-14-SS	3X5-38-SS	3X5-14-SG	3X5-38-SG	3X5-14-SS-90	3X5-38-SS-90	3X5-14-SG-90	3X5-38-SG-90
.236" (6MM)	5/32" (4MM)	FEPM-6X4	4X6-14-SS	4X6-38-SS	4X6-14-SG	4X6-38-SG	4X6-14-SS-90	4X6-38-SS-90	4X6-14-SG-90	4X6-38-SG-90
5/16" (8MM)	.236" (6MM)	FEPM-8X6	6X8-14-SS	6X8-38-SS	6X8-14-SG	6X8-38-SG	6X8-14-SS-90	6X8-38-SS-90	6X8-14-SG-90	6X8-38-SG-90
.354" (9MM)	.236" (6MM)	FEPM-9X6	6X9-14-SS	6X9-38-SS	6X9-14-SG	6X9-38-SG	6X9-14-SS-90	6X9-38-SS-90	6X9-14-SG-90	6X9-38-SG-90
.394" (10MM)	.275" (7MM)	FEPM-10X7	7X10-14-SS	7X10-38-SS	7X10-14-SG	7X10-38-SG	7X10-14-SS-90	7X10-38-SS-90	7X10-14-SG-90	7X10-38-SG-90
.394" (10MM)	5/16" (8MM)	FEPM-10X8	8X10-14-SS	8X10-38-SS	8X10-14-SG	8X10-38-SG	8X10-14-SS-90	8X10-38-SS-90	8X10-14-SG-90	8X10-38-SG-90
.472" (12MM)	.354" (9MM)	FEPM-12X9	9X12-14-SS	9X12-38-SS	9X12-14-SG	9X12-38-SG	9X12-14-SS-90	9X12-38-SS-90	9X12-14-SG-90	9X12-38-SG-90
.472" (12MM)	.394" (10MM)	FEPM-12X10	10X12-14-SS	10X12-38-SS	10X12-14-SG	10X12-38-SG	10X12-14-SS-90	10X12-38-SS-90	10X12-14-SG-90	10X12-38-SG-90

## Static Wire Air Hose

OD	ID	Part No.	Hose Connector Size							
			No Springguard		With Springguard		No Springguard		With Springguard	
			1/4" NPS(F)	3/8" NPS(F)	1/4" NPS(F)	3/8" NPS(F)	1/4" NPS(F)	3/8" NPS(F)	1/4" NPS(F)	3/8" NPS(F)
			BSP(F) Add "-B" Suffix to P/N (Example 1438-SG-B)							
5/8" (15.9MM)	5/16" (8MM)	HOSCO X-1	HHC-4527	HHC-4547	N/A	N/A	N/A	N/A	N/A	N/A
.47" (12MM)	5/16" (8MM)	HOSCO X-2	X-2-14-SS	X-2-38-SS	X-2-14-SG	X-2-38-SG	N/A	N/A	N/A	N/A
.47" (12MM)	5/16" (8MM)	HOSCO X-4	CALL OR EMAIL FOR AVAILABLE HOSE ASSEMBLY OPTIONS							



# SST Hose Fittings - Tapered and Spare Parts



			No Springguard Tapered		With Springguard Tapered		Springguard (Spare Part)	STP Nut (Spare Part)
			Hose Connector Size				For Each Hose Type and Size	
			1/8" NPT(M)	1/4" NPT(M)	1/8" NPT(M)	1/4" NPT(M)		
OD	ID	Part No.	BSPT (M) Call or email for availability (Example 1818-BT-SS)					
3/16" (4.8MM)	.138" (3.5MM)	NHA-0302	1818-T-SS-187	1814-T-SS-187	1818-T-SG-187	1814-T-SG-187	250SG	187STP
1/4" (6.35MM)	.180" (4.6MM)	NHA-0403	31618-T-SS-256	31614-T-SS-256	31618-T-SG-256	31614-T-SG-256	264SG	250STP-2
1/4" (6.35MM)	.170" (4.31MM)	NHA-250170	17018-T-SS-256	17014-T-SS-256	17018-T-SG-256	17014-T-SG-256	250SG	250STP
5/16" (8MM)	.236" (6MM)	NHA-0504 NHA-8X6	6X8-18-T-SS	6X8-14-T-SS	6X8-18-T-SG	6X8-14-T-SG	350SG	315STP
3/8" (9.6MM)	.275" (7MM)	NHA-375275	0718-T-SS	0714-T-SS	0718-T-SG	0714-T-SG	393SG	375STP
1/2" (12.7MM)	3/8" (9.5MM)	NHA-0806	N/A	3814-T-SS	N/A	3814-T-SG	500SG	500STP
.236" (6MM)	.157" (4MM)	NHA-6X4	4X6-18-T-SS	4X6-14-T-SS	4X6-18-T-SG	4X6-14-T-SG	250SG	236STP
.354" (9MM)	.236" (6MM)	NHA-9X6	6X9-18-T-SS	6X9-14-T-SS	6X9-18-T-SG	6X9-14-T-SG	350SG	350STP
.394" (10MM)	.275" (7MM)	NHA-10X7	7X10-18-T-SS	7X10-14-T-SS	7X10-18-T-SG	7X10-14-T-SG	350SG	350STP
.394" (10MM)	5/16" (8MM)	NHA-10X8	8X10-18-T-SS	8X10-14-T-SS	8X10-18-T-SG	8X10-14-T-SG	437SG	393STP-2
.472" (12MM)	.354" (9MM)	NHA-12X9	9X12-18-T-SS	9X12-14-T-SS	9X12-18-T-SG	9X12-14-T-SG	500SG	472STP
.472" (12MM)	.394" (10MM)	NHA-12X10	N/A	10X12-14-T-SS	N/A	10X12-14-T-SG	500SG	472STP

## Nylon Hose

			1/8" NPT(M)	1/4" NPT(M)	1/8" NPT(M)	1/4" NPT(M)		
			BSPT (M) Call or email for availability (Example 1818-BT-SS)					
OD	ID	Part No.	BSPT (M) Call or email for availability (Example 1818-BT-SS)					
.225" (5.7MM)	1/8" (3.2MM)	NP-2	1818-T-SS	1814-T-SS	1818-T-SG	1814-T-SG	250SG	225STP
.264" (6.7MM)	3/16" (4.8MM)	NP-3	31618-T-SS	31614-T-SS	31618-T-SG	31614-T-SG	264SG	264STP
.350" (8.9MM)	1/4" (6.35MM)	NP-4	1418-T-SS	1414-T-SS	1418-T-SG	1414-T-SG	350SG	350STP
.350" (8.9MM)	1/4" (6.35MM)	NP-4TL	1418-T-SS	1414-T-SS	1418-T-SG	1414-T-SG	350SG	350STP
.425" (10.8MM)	3/16" (8MM)	NP-5	N/A	51614-T-SS	N/A	51614-T-SG	437SG	437STP
.500" (12.7MM)	3/8" (9.5MM)	NP-6	N/A	3814-T-SS	N/A	3814-T-SG	500SG	500STP

## Coaxial Paint Hose

			1/8" NPT(M)	1/4" NPT(M)	1/8" NPT(M)	1/4" NPT(M)		
			BSPT (M) Call or email for availability (Example 1818-BT-SS)					
OD	ID	Part No.	BSPT (M) Call or email for availability (Example 1818-BT-SS)					
.350" (8.9MM)	1/4" (6.35MM)	CPH-4	1418-T-SS	1414-T-SS	1418-T-SG	1414-T-SG	350SG	350STP
.350" (8.9MM)	1/4" (6.35MM)	CPH-4TL	1418-T-SS	1414-T-SS	1418-T-SG	1414-T-SG	350SG	350STP
.425" (10.5MM)	5/16" (8MM)	CPH-5	N/A	51614-T-SS	N/A	51614-T-SG	437SG	437STP
.500" (12.7MM)	3/8" (9.5MM)	CPH-6	N/A	3814-T-SS	N/A	3814-T-SG	500SG	500STP



# SST Hose Fittings - Tapered and Spare Parts continued



## Fluoropolymer Tubing

OD	ID	Part No.	Hose Connector Size				Springguard (Spare Part)	STP Nut (Spare Part)
			No Springguard Tapered		With Springguard Tapered			
			1/8" NPT(M)	1/4" NPT(M)	1/8" NPT(M)	1/4" NPT(M)		
			BSPT (M) Call or email for availability (Example 1818-BT-SS)				For Each Hose Type and Size	
3/16" (4.76MM)	1/8" (3.18MM)	FEP-0302	1818-T-SS-187	1814-T-SS-187	1818-T-SG-187	1814-T-SG-187	250SG	187STP
1/4" (6.35MM)	1/8" (3.18MM)	FEP-0402	1818-T-SS-T	1814-T-SS-T	1818-T-SG-T	1814-T-SG-T	250SG	250STP
1/4" (6.35MM)	.170" (4.31MM)	FEP-250170	17018-T-SS-256	17014-T-SS-256	17018-T-SG-256	17014-T-SG-256	250SG	250STP
1/4" (6.35MM)	3/16" (4.76MM)	FEP-0403	31618-T-SS-256	31614-T-SS-256	31618-T-SG-256	31614-T-SG-256	264SG	250STP-2
5/16" (7.94MM)	3/16" (4.76MM)	FEP-0503	31618-T-SS-T	31614-T-SS-T	31618-T-SG-T	31614-T-SG-T	312SG	312STP
5/16" (7.94MM)	1/4" (6.35MM)	FEP-0504	1418-T-SS-312	1414-T-SS-312	1418-T-SG-312	1414-T-SG-312	350SG	315STP
3/8" (9.53MM)	1/4" (6.35MM)	FEP-0604	1418-T-SS-T	1414-T-SS-T	1418-T-SG-T	1414-T-SG-T	393SG	375STP
1/2" (12.7MM)	3/8" (9.53MM)	FEP-0806	N/A	3814-T-SS-T	N/A	3814-T-SG-T	500SG	500STP
.196" (5MM)	.118" (3MM)	FEPM-5X3	N/A	3X5-14-T-SS	N/A	3X5-14-T-SG	250SG	187STP
.236" (6MM)	5/32" (4MM)	FEPM-6X4	4X6-18-T-SS	4X6-14-T-SS	4X6-18-T-SG	4X6-14-T-SG	250SG	236STP
5/16" (8MM)	.236" (6MM)	FEPM-8X6	6X8-18-T-SS	6X8-14-T-SS	6X8-18-T-SG	6X8-14-T-SG	350SG	315STP
.354" (9MM)	.236" (6MM)	FEPM-9X6	6X9-18-T-SS	6X9-14-T-SS	6X9-18-T-SG	6X9-14-T-SG	350SG	350STP
.394" (10MM)	.275" (6MM)	FEPM-10X7	7X10-18-T-SS	7X10-14-T-SS	7X10-18-T-SG	7X10-14-T-SG	393SG	393STP
.394" (10MM)	5/16" (8MM)	FEPM-10X8	8X10-18-T-SS	8X10-14-T-SS	8X10-18-T-SG	8X10-14-T-SG	437SG	393STP-2
.472" (12MM)	.354" (9MM)	FEPM-12X9	N/A	9X12-14-T-SS	N/A	9X12-14-T-SG	500SG	472STP
.472" (12MM)	.394" (10MM)	FEPM-12X10	N/A	10X12-14-T-SS	N/A	10X12-14-T-SG	500SG	472STP

# Hose Splicers/Bulkhead Hose Splicers



## Hose Splicer

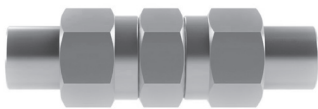

Part Number	Description
316316-HSP-T	3/16 ID X 5/16 OD
316316-HSP	3/16 ID X .264 OD
1414-HSP-T	1/4 ID X 3/8 OD
1414 - HSP	1/4" ID X .350 OD
3838 - HSP	3/8" ID X .500 OD
4X6-4X6-HSP	4MM ID X 6MM OD
5X8-5X8-HSP	5MM ID X 8MM OD
6X8 - 6X8 - HSP	6MM ID X 8MM OD
6X9 - 6X9 - HSP	6MM ID X 9MM OD
7X9.6 - 7X9.6 - HSP	7MM ID X 3/8" OD
7X10 - 7X10 - HSP	7MM ID X 10MM OD
8X10-8X10-HSP	8MM ID X 10MM OD
9X12-9X12-HSP	9MM ID X 12MM OD

### Features

- Quickly mends broken hose
- Joins multiple size hose
- Compact design

## Bulkhead Hose Splicer

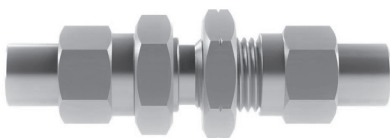

Part Number	Description
1414-SSBH-T	1/4 ID X 3/8 OD
1414-SSBH	1/4" ID x .350 OD
3X5-3X5-SSBH	5MM OD X 3MM ID
4X6-4X6-SSBH	6MM OD X 4MM ID
6X8-6X8-SSBH	6MM ID X 8MM OD
6X9-6X9-SSBH	6MM ID X 9MM OD
8X10-8X10-SSBH	8MM ID X 10MMOD
9X12-9X12-SSBH	9MM ID X 12MMOD

### Features

- For panel, wall, or plate mounting
- Compact design



# High Performance Non-Conductive Hose and Tubing Connectors

## NPT Style

Tube Dimension x Tapered Male

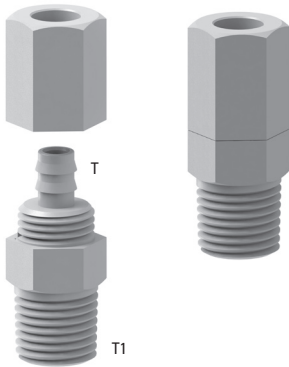

Part Number	T	T1 (M)
4X6-18-T-PA	6MM OD X 4MM ID	1/8 NPT
4X6-14-T-PA	6MM OD X 4MM ID	1/4 NPT
4X6-38-T-PA	6MM OD X 4MM ID	3/8 NPT
6X8-18-T-PA	8MM OD X 6MM ID	1/8 NPT
6X8-14-T-PA	8MM OD X 6MM ID	1/4 NPT
6X8-38-T-PA	8MM OD X 6MM ID	3/8 NPT
6X9-18-T-PA	9MM OD X 6MM ID	1/8 NPT
6X9-14-T-PA	9MM OD X 6MM ID	1/4NPT
6X9-38-T-PA	9MM OD X 6MM ID	3/8 NPT
7X10-14-T-PA	10MM OD X 7MM ID	1/4 NPT
7X10-38-T-PA	10MM OD X 7MM ID	3/8 NPT
9X12-14-T-PA	12MM OD X 9MM ID	1/4 NPT
0714-T-PA	3/8 OD X .271 ID	1/4/NPT
0738-T-PA	3/8 OD X .271 ID	3/8 NPT
31614-T-PA	5/16 OD X 3/16 ID	1/4 NPT
1414-T-PA	3/8 OD X 1/4 ID	1/4 NPT

## Hose Splicer

Tube Dimension x Tube Dimension

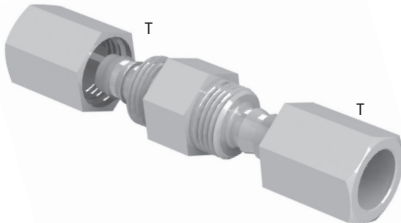

Tube Dimension x 90

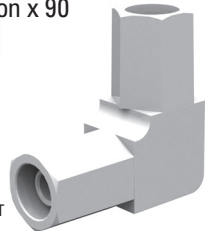

Part Number	T
4X6-4X6-HSP-PA	6MM OD X 4MM ID
6X8-6X8-HSP-PA	8MM OD X 6MM ID
6X9-6X9-HSP-PA	9MM OD X 6MM ID
7X10-7X10-HSP-PA	10MM OD X 7MM ID
8X10-8X10-HSP-PA	10MM OD X 8MM ID
9X12-9X12-HSP-PA	12MM OD X 9MM ID
1414-HSP-PA	3/8OD X 1/4 ID
7X10-4X6-HSP-PA	10MM OD X 6MM OD

Part Number	T
6X8-6X8-HSP-PA-90	8MM OD X 6MM ID
6X9-6X9-HSP-PA-90	9MM OD X 6MM ID
7X10-7X10-HSP-PA-90	10MM OD X 7MM ID

## BSPP Style

Tube Dimension x British Straight Male

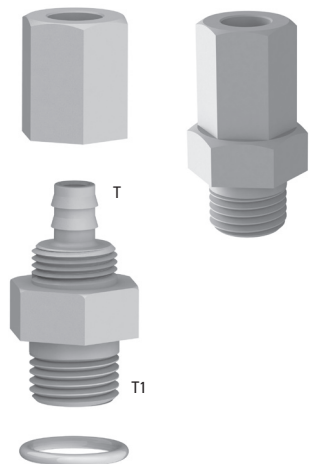

Part Number	T	T1 (M)
6X8-14-BFX-PA	8MM OD 6MM ID	1/4 BSPP
7X10-14-BFX-PA	10MM OD X 7MM ID	1/4 BSPP
9X12-14-BFX-PA	12MM OD X 9MM ID	1/4 BSPP

Hosco PA Hose Connectors are designed to provide safe and non-conductive connections of hose and tubing using the robust and industry leading Hosco barb and nut style retention system. These connectors significantly exceed the performance of other style connectors and provide the highest level of safe and reliable connections found today for use in flammable or hazardous fluid handling. Generally, these PA (PolyAmide) connectors are used in ungrounded or high dielectric designed systems to minimize the concerns for static discharge (arcs or sparks) or pin-holing/dielectric burn thru of thermoplastic components in the fluid delivery system. The PA family of hose connectors are available in common sizes of fractional inch or metric hose connection ends, and in straight or compact 90 degree configurations. The connection point is available in two common ends- NPT/BSPT(P) or NPS/BSPP(PF) with single or double dielectric gasket/seal design. The end connections are 1/8", 1/4", and 3/8" sizes.

## Feature and Benefits

### PolyAmide Materials of Construction

- Suitable for most paints, coatings or solvents in use
- Wide range of chemical compatibility

### Multiple sizes, two configurations

- Provides one common style of connector for fractional inch and metric hoses or tubes with straight or 90 degree styles

### Robust Designs

- Seal-less NPT or seal style NPS/BSP-P(PF) to insure leak free operation and dielectric containment
- Single or double seal design available on NPS/BSPP(PF) style
- Mechanical retention of hose and tube is best available technology to insure safety and trouble free operation



# MCPHA Assembly (Monoline Coaxial Paint Hose Assembly)

## The System: A hose within a hose.

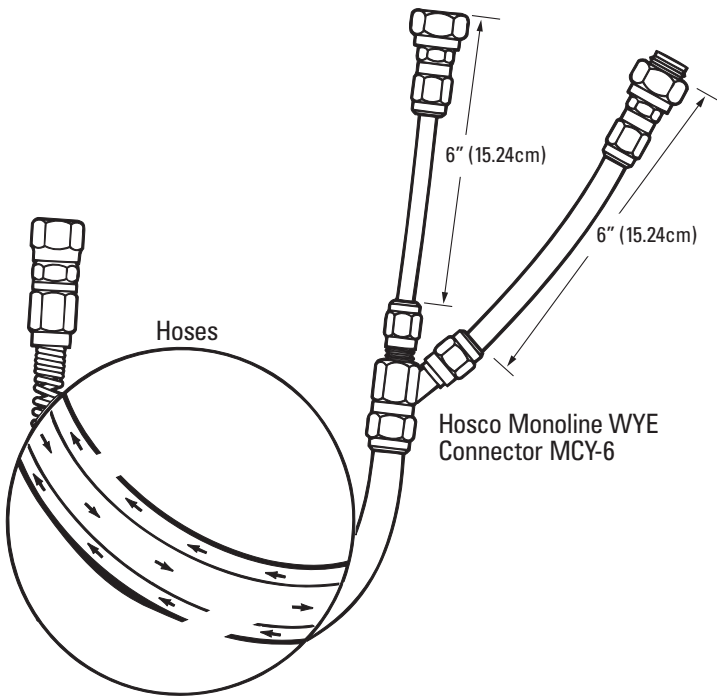

Hosco MCPHA (Monoline Coaxial Paint Hose Assembly) is a unique and novel method of circulating paint or any fluid with the appearance of a single hose system. This innovation reduces the hose management issues at dispense or spray stations for materials needing recirculation by supplying the material in the annulus area between the outside and inside hoses, and returning the material being circulated thru the inside hose ID.

On the primary product family, the frictional loss is equivalent to a 1/4" ID (6.35mm) hose on the supply side and a 0.236" ID (6mm) hose on the return side and is dependent on the MCPHA assemblies length, normally up to 35 feet in standard configurations (15ft (4.5m), 20ft (6.1m), 25ft (7.6m), 30ft (9.1m), and 35ft (10.7m)).

In the Mini-Monoline versions to supply heated flush materials to the spray applicator, the frictional loss is equivalent to 4mm ID on the supply side hose, and a 1.8mm ID on the return side hose (this version is flow limited to approximately 400cc/min of solvent or amine flushing materials and operating temperatures to 140 degrees F).

The flexibility and ergonomic benefits of the primary family assemblies are accomplished with the use of the proprietary Hosco CPH hose (Coaxial Paint Hose) which is a three layer PA/PUR/PA hose construction that reduces weight and increases flexibility of the hose assembly's use and comfort for the spray operator.

In addition, its compact design is now incorporated into robot and automation stations for circulating paint and flush materials due to challenges of routing and connecting normal two hose (supply and return) systems. Heat loss in the hose station is reduced with the MCPHA primarily due to the fact that the return hose is not exposed to heat loss because of the "hose in a hose" design.

Part Number	Description
MCPHA - 15	15' Hose Assembly with Fittings
MCPHA - 20	20' Hose Assembly with Fittings
MCPHA - 25	25' Hose Assembly with Fittings
MCPHA - 30	30' Hose Assembly with Fittings
MCPHA -07-250 •	7' Hose Assembly with Fittings, 1/4" OD
MCPHA -10-250 •	10' Hose Assembly with Fittings, 1/4" OD
MCPHA -15-250 •	15' Hose Assembly with Fittings, 1/4" OD

• Indicates Mini-Monoline constructed with nylon hose material.  
For special lengths, metric connections, contact customer service.

## Feature and Benefits

### Single hose design provides recirculation

- Reduces hose management issues
- Compact design for hose routing challenges

### Multiple configurations and lengths

- Two sizes for two uses- larger version for circulating paint, Mini-Monoline for circulating and supplying heated flush materials to the robot bell or gun.
- Assembly lengths from 7ft (2m) to 35ft (10.7m)

### No Assembly required at site

- MCPHA assemblies ready to install when received

### Rebuildable on site

- SST fittings provide long life, tubing, hose and seal kits available as spare parts for rebuilding.

### Unique ergonomic/flexible hose designs

- CPH tri-layer hose provides new levels of comfort and flexibility in manual spray operations

## Accessories (sold separately)

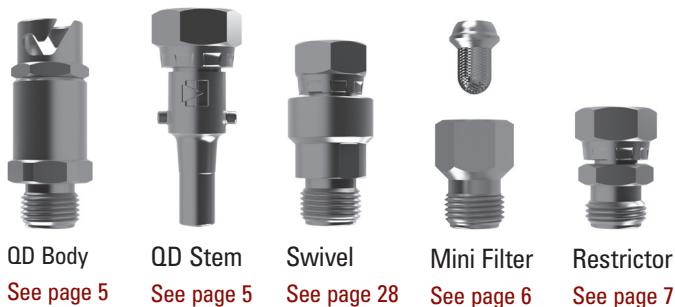

QD Body  
See page 5

QD Stem  
See page 5

Swivel  
See page 28

Mini Filter  
See page 6

Restrictor  
See page 7

Hosco NP series of hose and NHA series of tubing have been the backbone of circulating and delivery paint to spray applicators for decades, and are available in virtually any size needed, and the NHA tubing family is available in colors as well to provide quick recognition of the different lines often stores or routed together.

This hose and tubing is provided in standard ID size range from 1/8" or 3mm to 1/2" or 13mm and OD sizes from 3/16" or 5mm to 5/8" or 16mm (other sizes are available upon request). Hosco supports the use of this tubing with a full array of hose connectors in multiple configurations as well. PA (PolyAmide) or Nylon hose and tubing is the most widely used in the industrial and painting applications because of its affordability, pressure strength, and chemical resistance to normal fluids used in the painting operation. Hosco PA-Nylon hoses and tubes are extruded in a clean room environment and certified Silicone Free for safe use in these painting operations straight off the hose reel. In addition, hoses are provided on special reels that can be used in the clean room paint environment with no possibility of creating foreign dust or dirt during the uncoiling or coiling of hose on these reels. This attention to detail and customer requirements makes Hosco NP and NHA hose and tubing the best choice in paint finishing worldwide.

## Feature and Benefits

### Nylon-PA Construction

- Most common materials for handling paint
- Recognized as the most economical and safe material for use in non-electrostatic/grounded paint hose applications

### Multiple Sizes Available

- Virtually every size found is available for nearly all low pressure paint applications from 1/8" (3mm) ID to 1/2" (13mm) ID hose sizes or 3/16" (4mm) OD to 5/8" (16mm) OD tubing sizes

### Certified Silicone Free

- Ready for service into paint applications with no concerns

### Clean Room Packaging

- Specialized packaging to eliminate airborne contaminants when reeling or unreeling hose or tubing for use

Part No.	OD	ID	Wall	Working Pressure @ 75° F	Working Pressure @ 150° F	Bend Radius	Standard Reel Size (Ft)	Standard Coil Size (Ft)	Stock Color Options*
NHA-532 NHA-4X2.7	5/32" 4mm	.106" 2.7mm	.025" .64mm	350 PSI 24 BAR	210 PSI 14 BAR	1/2" 12mm	500	100	BL S R G B Y OR P
NHA-0302	3/16" 4.8mm	.138" 3.5mm	.025" .64mm	260 PSI 18 BAR	160 PSI 11 BAR	3/4" 19mm	500	100	BL R B
NHA-6X4	.236" 6mm	.157" 4mm	.040" 1mm	340 PSI 23 BAR	200 PSI 13 BAR	1-1/4" 32mm	500	100	BL S R G B Y OR
NHA-0403	1/4" 6.35mm	.180" 4.6mm	.035" .89mm	290 PSI 20 BAR	170 PSI 11 BAR	1-1/4" 32mm	500	100	BL S R G B Y OR
NHA-0504 NHA-8X6	5/16" 8mm	.236" 6mm	.040" 1mm	240 PSI 16 BAR	140 PSI 9 BAR	1-1/2" 38mm	500	100	BL S R G B Y
NHA-9X6	.354" 9mm	.236" 6mm	.063" 1.6mm	250 PSI 17 BAR	150 PSI 10 BAR	2" 50mm	500	100	NATURAL ONLY
NHA-375275	3/8" 9.6mm	.275" 7mm	.050" 1.27mm	250 PSI 17 BAR	150 PSI 10 BAR	2" 50mm	500	100	BL S R G B Y OR
NHA-10X7	.394" 10mm	.275" 7mm	.059" 1.5mm	280 PSI 19 BAR	170 PSI 11 BAR	2-1/2" 65mm	500	100	NATURAL ONLY
NHA-10X8	.394" 10mm	5/16" 8mm	.040" 1mm	190 PSI 13 BAR	110 PSI 7 BAR	2" 50mm	500	100	BL S
NHA-12X9	.472" 12mm	.354" 9mm	.059" 1.5mm	250 PSI 17 BAR	150 PSI 10 BAR	3" 76mm	250	100 50	NATURAL ONLY
NHA-12X10	.472" 12mm	.394" 10mm	.040" 1mm	150 PSI 10 BAR	90 PSI 6 BAR	2-1/2" 65mm	250	100 50	BL
NHA-0806	1/2" 12.7MM	3/8" 9.5mm	.063" 1.6mm	240 PSI 16 BAR	150 PSI 10 BAR	2" 50mm	250	100 50	BL R G B Y

\*All sizes available in natural

\*All colored hose 1-2 week lead time

\*Custom colors and sizing available upon request, please contact Hosco customer service.



Part Number	OD	ID	Wall	Working Pressure @ 75° F	Bend Radius	Standard Reel Size (ft)	Standard Coil Size (ft)
NP-2	.225" 5.7MM	1/8" 3.2MM	.050" 1.27MM	325 PSI 22 BAR	.5" 12.7MM	500	100
NP-3	.264" 6.7MM	3/16" 4.8MM	.040" 1.01MM	280 PSI 19 BAR	1.25" 31.75MM	500	100
NP-4	.350" 8.9MM	1/4" 6.35MM	.050" 1.27MM	250 PSI 17 BAR	1.5" 38.1MM	500	100
NP-4TL (twin line bonded)	.350" 8.9MM	1/4" 6.35MM	.050" 1.27MM	250 PSI 17 BAR	2.25" 57.15MM	250	100
NP-5	.425" 10.8MM	5/16" 8MM	.050" 1.27MM	240 PSI 15 BAR	2.6" 66.04MM	250	100
NP-6	.500" 12.7MM	3/8" 9.5MM	.063" 1.6MM	240 PSI 15 BAR	3.25" 82.55MM	250	100

## Coaxial Paint Hose



Hosco has a unique hose that provides significant ergonomic improvement of flexibility and weight reduction versus the nylon hose or tubing equivalent size. In addition, there is benefit to increasing the dielectric strength with the multiple layer construction versus solid core nylon hose or tubing. The CPH series of hose is available in 1/4", 5/16" and 3/8" ID sizes and is dimensionally equivalent to our NP-4 (6.35mm), NP-5, (8mm) or NP-6 (9.7mm) solid core nylon hose using the same family of connectors. The CPH has a thin sheath of PA-Nylon on the inside lining and outside cover to provide resistance to solvent or chemical attack like solid core PA-Nylon, but its core tube is PUR-PolyUrethane to provide the increase in flexibility and reduction in weight. The multi-layer construction seems to provide additional dielectric strength when compared to PA-Nylon but not to the dielectric strength of FEP, PTFE or UHPPFA Fluoropolymers performance level.

### Feature and Benefits

#### Three Layer Construction

- Provides better flexibility and lower weight hose packages
- Improved resistance to dielectric pinholing versus PA-Nylon

#### Multiple Sizes Available

- Common 1/4" (6.35mm), 5/16" (8mm) and 3/8" (9.7mm) ID sizes

#### Certified Silicone Free

- Ready for service into paint applications with no concerns

Part Number	OD	ID	Wall	Working Pressure	Bend Radius	Standard Reel Size (Ft)	Standard Coil Size (Ft)
CPH-4	.350" 8.9MM	1/4" 6.35MM	.05" 1.27MM	200 PSI 14 BAR	1.75" 44.45MM	500	100
CPH-4TL	.350" 8.9MM	1/4" 6.35MM	.05" 1.27MM	200 PSI 14 BAR	1.75" 44.45MM	500	100
CPH-5	.425" 10.5MM	5/16" 8MM	.056" 1.42MM	190 PSI 13 BAR	2.7" 68.58MM	250	100
CPH-6	.500" 12.7MM	3/8" 9.5MM	.063" 1.6MM	180 PSI 12 BAR	2.3" 58.42MM	250	100





# Static Wire Air Hose

Hosco has provided Static wire air hoses to provide added layers of ground protection for spray guns or other air powered devices. In addition, we have added grounded hoses using conductive layers of thermoplastic hoses to accomplish this as well and increase flexibility, weight and other ergonomic factors. Hosco supplies 5/16" or 8mm ID hoses most commonly but has other sizes available as special order. X1 is the strongest most robust hose with a continuous static wire, X2 is also a continuous static wire using lighter weight thermoplastic, and there X4 hose configurations using graphite impregnation to insure static level grounding.

Grounding of items in the spray zone is critically important and should consist of three layers of safety, which are: the part being sprayed should be grounded, the person or spray station should be grounded, and the spray device should be grounded. Grounding the spray device can and should be done in three ways, which are thru the spray gun, thru the spray operator, and thru the electrostatic power supply and cable if applied electrostatically.

## Feature and Benefits

### Multiple Sizes of ID Hose

- 8mm or 5/16" is standard configuration, larger sizes are available as special order

### Full Array of Hose Connection Sizes

- 3/8" or 1/4" connection sizes, plus other adapters to meet the application need with or without springguards

### Hose Components or Hose Assemblies

- Hosco can manufacture the hose assembly or provide the component parts for site assembly

### Field Rebuildable with Spare Parts

- Hoses can be repaired or rebuilt with quick delivery from Hosco inventory

### Tested assemblies

- Ground tested after assembly for acceptable ground range

Part Number	OD	ID	Wall	Working Pressure	Bend Radius	Standard Reel Size (Ft)	Standard Coil Size (Ft)
HOSCO X-1	5/8" 15.9MM	5/16" 8MM	.156" 3.96MM	200 PSI 13.6 BAR	1" 25.4MM	550	100
HOSCO X-2	.47" 12MM	5/16" 8MM	.087" 2.21MM	200 PSI 13.6 BAR	2" 50.8MM	500	100
HOSCO X-4	.47" 12MM	5/16" 8MM	.094" 2.39MM	100 PSI 6.9 BAR	1.25" 32MM	250	100

# Hose and Tube Accessories



## Paint Hose Clips

Part Number	Description	For Use with
HTC - 201 - 325	Hose Clip	1/8" & 3/16" ID Nylon Paint Hose
HTC - 326 - 400	Hose Clip	1/4" & 5/16" ID Nylon Paint Hose
HTC - 401 - 485	Hose Clip	5/16" & 3/8" ID Nylon Paint Hose

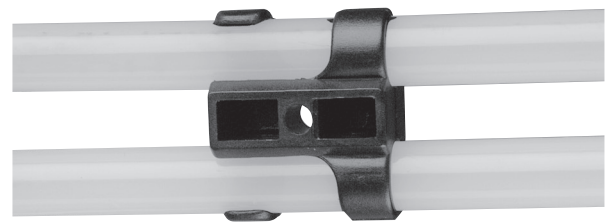

## Hose and Tubing Cutter

Part Number	Description
PXC060	Hose Tubing Cutter



The Hosco Hose & Tubing Cutter will provide straight, clean, accurate cuts for optimum fitting connections. The lightweight, rugged unit will cut 1/8" through 3/4" OD tubing. The exclusive "blade guard" feature provides protection from accidental blade contact. Ribbed handle aides in accurate positioning on the tube.

Hosco supplies a wide array of Fluoropolymer tubing to meet the needs of the paint finishing customers we serve. It is available in four different resins (FEP, PTFE, PFA and FlexLife™ Ultra High Purity PFA) and multiple sizes from 1/8" (3mm) to 7/8" (22.2mm) ID and 3/16" (4.76mm) to 1" (25.4mm) OD tubes (sizes above 3/8" (or 10mm) ID are generally used for site tubes). Fluoropolymer tubing is generally used in challenging applications to speed up flushing or cleaning of paint lines (due to its low coefficient of friction) or to provide containment of electrostatic charge from ground or voltage bleed off in high transfer efficiency painting (due to its high dielectric strength). FEP and PFA resin are used to provide site tubes due to its transparency for any fluid system where seeing the tube interior is required (like piggable systems at the pig launch or pig catch areas). PTFE is opaque. In general, FEP and PFA tubes are stiffer and have approximately 25% greater burst pressure strength than the other Fluoropolymer resin types of tubing.

## Feature and Benefits

### Low Coefficient of Friction

- Facilitates faster material (color) changes in valve packages
- Uses less cleaning solvents to flush and clean, minimizing waste

### High Dielectric Strength Resin

- Protects against voltage bleed off, maintaining TE in electrostatic spray or charging systems
- Protects against hose or tube breakdown due to pin holing or electrostatic burn through to adjacent grounds

### Widest Variety of Size and Resin Types

- Hosco Fluoropolymer selections are widest and best of all supplier choices to meet paint, coating and solvent fluid needs

## FEP

Part Number	OD	ID	Wall	Working Pressure @ 73° F	Bend Radius	Standard Reel Size (Ft)	Standard Coil Size (Ft)
FEP-0302	3/16" 4.76MM	1/8" 3.18MM	0.032" .812MM	290 PSI 20 BAR	3/4" 19MM	500	100
FEP-0402	1/4" 6.35MM	1/8" 3.18MM	.062" 1.57MM	450 PSI 30 BAR	1/2" 12MM	500	100
FEP-250170	1/4" 6.35MM	.170" 4.31MM	.04" 1MM	297 PSI 20 BAR	1" 25MM	500	100
FEP-0403	1/4" 6.35MM	3/16" 4.76MM	0.032" .812MM	210 PSI 15 BAR	1" 25MM	500	100
FEP-0503	5/16" 7.94MM	3/16" 4.76MM	.062" 1.57MM	350 PSI 24 BAR	1" 25MM	500	100
FEP-0504	5/16" 7.94MM	1/4" 6.35MM	0.032" .812MM	165 PSI 11 BAR	1-3/4" 44MM	500	100
FEP-0604	3/8" 9.53MM	1/4" 6.35MM	.062" 1.57MM	290 PSI 20 BAR	1" 25MM	500	100
FEP-0806	1/2" 12.7MM	3/8" 9.53MM	.062" 1.57MM	210 PSI 15 BAR	2" 50MM	250	100
FEPM-5X3	.196" 5MM	.118" 3MM	.04" 1MM	330 PSI 23 BAR	3/4" 19MM	500	100
FEPM-6X4	.236" 6MM	5/32" 4MM	.04" 1MM	290 PSI 20 BAR	1-3/4" 44MM	500	100
FEPM-8X6	5/16" 8MM	.236" 6MM	.04" 1MM	210 PSI 15 BAR	2-1/2" 65MM	500	100
FEPM-9X6	.354" 9MM	.236" 6MM	.059" 1.5MM	290 PSI 20 BAR	2-1/2" 65MM	500	100
FEPM-10X7	.394" 10MM	.275" 7MM	.059" 1.5MM	267 PSI 18 BAR	3-1/4" 83MM	500	100
FEPM-10X8	.394" 10MM	5/16" 8MM	.04" 1MM	165 PSI 11 BAR	2-3/4" 70 MM	500	100 50
FEPM-12X9	.472" 12MM	.354" 9MM	.059" 1.5MM	205 PSI 14 BAR	2" 51MM	250	100 50
FEPM-12X10	.472" 12MM	.394" 10MM	.04" 1MM	155 PSI 11 BAR	4" 101MM	250	100 50

# Fluoropolymer Tubing



## PTFE

Part Number	OD	ID	Wall	Working Pressure @ 73° F	Bend Radius	Standard Reel Size (Ft)	Standard Coil Size (Ft)
PTFE-0402	1/4" 6.35MM	1/8" 3.18MM	.062" 1.57MM	310 PSI 21 BAR	1/2" 12MM	500	100
PTFE-0503	5/16" 7.94MM	3/16" 4.76MM	.062" 1.57MM	247 PSI 17 BAR	1" 25MM	500	100
PTFE-0604	3/8" 9.53MM	1/4" 6.35MM	.062" 1.57MM	207 PSI 14 BAR	3/4" 19MM	500	100
PTFE-0806	1/2" 12.7MM	3/8" 9.53MM	.062" 1.57MM	155 PSI 11 BAR	2-1/2" 65MM	500	100
PTFEM-4X2	.157" 4MM	.079" 2MM	.04" 1MM	455 PSI 31 BAR	3/4" 19MM	500	100
PTFEM-6X4	.236" 6MM	.157" 4MM	.04" 1MM	208 PSI 14 BAR	1" 25MM	500	100
PTFEM-8X6	.315" 8MM	.236" 6MM	.04" 1MM	156 PSI 11 BAR	1-1/2" 38MM	500	100
PTFEM-10X8	.394" 10MM	.315" 8MM	.04" 1MM	125 PSI 9 BAR	2" 51MM	500	100
PTFEM-12X10	.472" 12MM	.394" 10MM	.04" 1MM	104 PSI 7 BAR	4" 101MM	250	100

## Performance Specs.

	PTFE	FEP	PFA	FLEXLIFE™
Upper Service Temp °F	500°F	400°F	500°F	500°F
Tensile Strength PSI	3,000	4,000	4,200	4,500
Flex Modulus PSI	27,000	90,000	90,000	90,000
MIT Flex Life	1,000,000	200,000	500,000	1,750,000

## PFA

Part Number	OD	ID	Wall	Working Pressure @ 73° F	Bend Radius	Standard Reel Size (Ft)	Standard Coil Size (Ft)
PFA-0302	3/16" 4.76MM	1/8" 3.18MM	.030" .76MM	299 PSI 21 BAR	3/4" 19MM	500	100
PFA-0604	3/8" 9.53MM	1/4" 6.35MM	.062" 1.57MM	310 PSI 21 BAR	1" 25MM	500	100
PFA-0806	1/2" 12.7MM	3/8" 9.53MM	.062" 1.57MM	232 PSI 16 BAR	2" 51MM	250	100
PFAM-6X4	.236" 6MM	.157" 4MM	.04" 1MM	312 PSI 22 BAR	1-3/4" 44MM	500	100
PFAM-8X6	.315" 8MM	.236" 6MM	.04" 1MM	234 PSI 16 BAR	2-1/2" 65MM	500	100

## FlexLife™

Part Number	OD	ID	Wall	Working Pressure @ 73° F	Bend Radius	Standard Reel Size (Ft)	Standard Coil Size (Ft)
FL-0604	3/8" 9.53MM	1/4" 6.35MM	.062" 1.57MM	311 PSI 21 BAR	1" 25MM	500	100
FL-0806	1/2" 12.7MM	3/8" 9.53MM	.062" 1.57MM	233 PSI 16 BAR	2" 51MM	250	100
FLM-6X4	.236" 6MM	.157" 4MM	.040" 1MM	313 PSI 22 BAR	1-3/4" 44MM	500	100
FLM-8X6	.315" 8MM	.236" 6MM	.040" 1MM	235 PSI 16 BAR	2-1/2" 65MM	500	100
FLM-10X7	.394" 10MM	.276" 7MM	.059" 1.5MM	310 PSI 21 BAR	2" 51MM	500	100



# SST Jacketed and FireHyde™ Hose Assemblies

Hosco Stainless Steel Wire Braided Hose Assemblies come completely finished and ready to install into applications in the Pump Room or out at the booth side. The sizes range from 1/4" up to 2" nominal sizes (actual ID size is slightly smaller), with an array of end fittings (JIC(F), NPT(M), Sanitary clamps, and 3/8" OD or 1/2" OD Tube Stub and Sweeps plus 3/8" NPS(M) or (F) on some smaller sizes in smooth bore version are most common. Convoluted hoses are rated for a vacuum service, therefore good for pump suction hoses, have a much smaller bending radius and greater hoop strength to resist kinking or high suction collapse. Smooth bore hoses are more economical due to thinner wall (less PTFE material used) and simpler design, but are susceptible to kinks in the larger sizes in a dynamic (moving) application.

Hosco provides FireHyde™ hoses in the smooth bore conductive core hoses up to -10 hose sizes to replace rigid steel tubing for fluid supply or return lines. The hoses can be installed in about 1/2 the time of rigid steel tubing, and can be quickly and easily relocated to another dispense point if necessary. Hosco FireHyde™ series of hoses in the 3/8", 1/2", and 5/8" sizes have been certified to meet the FM 6036 Fire test and maintain pressure strength and containment.

## Feature & Benefit

### High Working Pressure Rated

- Smaller hoses rated to over 2000 PSI WP, and largest hoses rated to 800 PSI WP or 14" HG Vacuum for suction lines

### Wide Array of Sizes

- From 1/4" to 1 1/4" in smooth bore (PDH/PDHC) and from 3/4" to 2" in convoluted (PSH/PSHC), plus conductive core option for grounding concerns.
- Can fabricate in lengths to 100 feet

### Wide Array of Connection Types

- From 1/4" to 2" in all common connection types (NPT/) male or female ends, JIC(F), NPS(M) or NPS(F), Sanitary Clamp or Tube Stub available

### FireHyde™ Options

- To replace conventional rigid tubing in flammable or hazardous materials while retaining safety and industry certification.

## Smooth Bore with 3/8" NPS(F) Connector



Series Type	Hose Size	Working Pressure, psi	Min. Bend Radius, in. (at room temp)	Connection Detail
PSHC	08-1/2"	1000	1	A-Male NPT 316 SST
	12-3/4"	1000	2	B-Female JIC 316 SST
	16-1"	1000	3	D-Tri-Clamp End 316 SST (1", 1-001/2" or 2" Size Only)
	20-1-1/4"	1000	6.25	E-Male NPT Carbon Steel
	24-1-1/2"	750	7.5	J-Female JIC Carbon Steel
	32-2"	500	10	
PDHC	04-1/4"	3000	2	A-Male NPT 316 SST
	06-3/8"	2500	4	B-Female JIC 316 SST
	08-1/2"	2000	5.2	D-Tri-Clamp End 316 SST (1" Size Only)
	12-3/4"	1200	7.7	E-Male NPT Carbon Steel
	16-1"	1000	9	F-3/8" BSP(F) SST
	20-1-1/4"	800	16	G-3/8" NPS(F) SST (3/8" and 1/2" Size Only)
				H-3/8" NPS(M) SST (3/8" and 1/2" Size Only)
				J-Female JIC Carbon Steel
				K-1/4" NPS(F) (1/4" Size Only)
				L-1/4" NPS(M) (1/4" Size Only)
			T-3/8" OD Tube Stub (3/8" and 1/2" Size Only)	
			T90 3/8" OD Tube Stub 90° (3/8" and 1/2" Size Only)	

Convoluted Hose

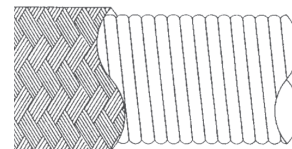

PSHC – conductive (carbon impregnated), PTFE lined, fiberglass reinforced innercore, overbraided with 300 series stainless steel.

Smooth Bore Hose

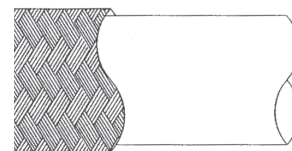

PDHC – .030 wall, conductive lined, virgin PTFE tubing, overbraided with 300 series stainless steel wire.

## Part Number Configurator/Specifier

Series PSHC or PDHC	Hose size XX	Connection detail		Overall length in inches XXX
Choose Convoluted or Smooth Bore from above	Choose hose size	End 1 X	End 2 X	Expandable length in inches end to end.
FireHyde™ PDHC Only	3/8" (06) 1/2" (08) 5/8" (10)	See PDHC detail above Available in A,B,G,T,T90		Expandable length in inches end to end. -FS

Sample Ordering SST Jacketed: PDHC-06-GG-180, Sample Ordering FireHyde: PDHC-06-TT-180-FS



# SST Ball Valves Common Configurations

## Straight and Tapered Pipe Thread

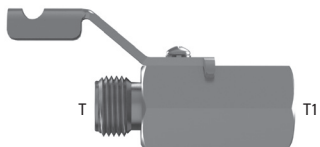

Part Number	T (M)	T1 (F)
SSBV-4-316	1/4 NPS	3/8 NPT
SSBV-6-316	3/8 NPS	3/8 NPT

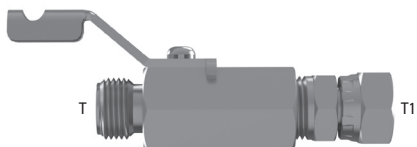

Part Number	T (M)	T1 (F)
SSBV-6-6SN-316	3/8 NPS	3/8 NPS

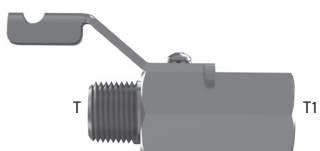

Part Number	T (M)	T1 (F)
SSBV-4T-316	1/4 NPT	3/8 NPT
SSBV-4T-4T(F)-316	1/4 NPT	1/4 NPT
SSBV-6T-316	3/8 NPT	3/8 NPT

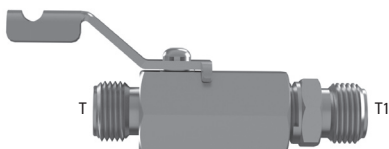

Part Number	T (M)	T1 (M)
SSBV-6-6-316	3/8 NPS	3/8 NPS
SSBV-6B-6B-316	3/8 BSP	3/8 BSP

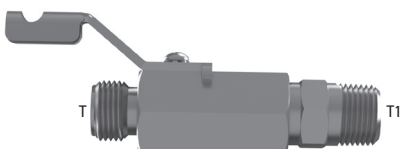

Part Number	T (M)	T1 (M)
SSBV-6-4T-316	3/8 NPS	1/4 NPT
SSBV-6-6T-316	3/8 NPS	3/8 NPT

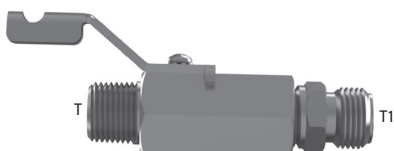

Part Number	T (M)	T1 (M)
SSBV-4T-4-316	1/4 NPT	1/4 NPS
SSBV-6T-6-316	3/8 NPT	3/8 NPS



Part Number	T (M)	T1 (M)
SSBV-4T-4T-316	1/4 NPT	1/4 NPT
SSBV-6T-6T-316	3/8 NPT	3/8 NPT

Hosco SSBV Compact and HBV Ultra Compact ball valves are designed to provide manual dispense control to a paint station or dispense point in a circulation or piping system. It is a 1/4 turn ball valve design entirely constructed of 304/316 SST in a 7/8" hex body, with a smooth bore and cavity free 0.280" (7mm) flow passageway. Available in multiple configurations in NPT/BSPT (PT) male or female, NPS/BSPP (PA) male or female including bulkhead style, Compression or Bulkhead Compression style in fractional inch or metric sizes, Tube Stub style in fractional inch or metric sizes up to 18" or 450mm in overall length. The valves are rated up to 1000 PSI WP, and are constructed of materials to resist corrosion or chemical attack with Fluoropolymer packings and seals that provide safe operation and long life in any fluid service. The SSBV family includes an adjustable packing to allow adjustment of handle actuation force or extend packing life if necessary.

## Feature and Benefits

### Multiple Configurations

- NPT/BSPT (PT), NPS/BSPP (PF) including bulkhead style, Compression including bulkhead style, and Tube Stub connection points in fractional inch or metric sizes

### SST Construction

- 304/316 materials compatible with all coatings or adhesives
- Long life

### Cavity Free & Smooth Bore Design

- To minimize material pack out or "dirt in paint" and provide easy to clean and flush operation

### Low Shear Design

- 0.280" (7mm) flow passageway minimize shear and coating degradation and subsequent pressure or flowrate losses

### Unique Manufacturing Processes

- Nickel braze process when required assures full 316 SST construction and absolute compatibility to even De-ionized water systems

## Tube Fitting x Tube Fitting

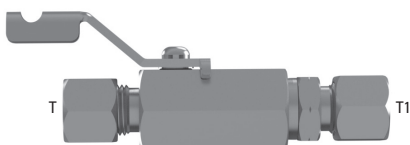

Part Number	T	T1
SSBV-6TF-6TF-316	3/8 TF	3/8 TF
SSBV-8TF-8TF-316	1/2 TF	1/2 TF
SSBV-10MMTF-10MMTF	10MM TF	10MM TF
SSBV-12MMTF-12MMTF	12MM TF	12MM TF



# SST Ball Valves Common Configurations continued

## Bulkhead Tube Fitting x Thread



Part Number	T (M)	T1
SSBV-6-6BTF-316	3/8 NPS	3/8 BTF
SSBV-6-8BTF-316	3/8 NPS	1/2 BTF

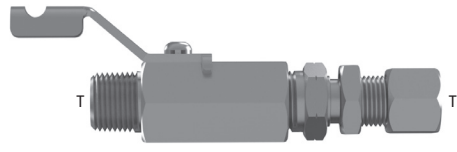

Part Number	T (M)	T1
SSBV-6T-6BTF-316	3/8 NPT	3/8 BTF
SSBV-6T-8BTF-316	3/8 NPT	1/2 BTF

## Tube Fitting x Bulkhead Tube Fitting

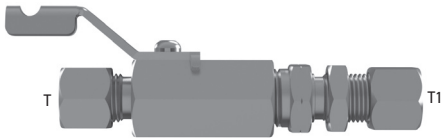

Part Number	T	T1
SSBV-6TF-6BTF-316	3/8 TF	3/8 BTF
SSBV-8TF-8BTF-316	1/2 TF	1/2 BTF

## Pipe Thread X 3/8" Reverse Bulkhead Thread

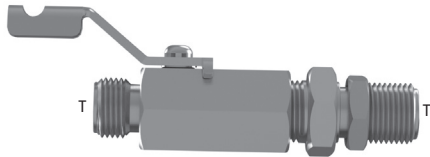

Part Number	T (M)	T1(M)
SSBV-6-6RB-316	3/8 NPS	3/8 NPS
SSBV-6T-6RB-316	3/8 NPT	3/8 NPS

## OD Tube x Tube Fitting

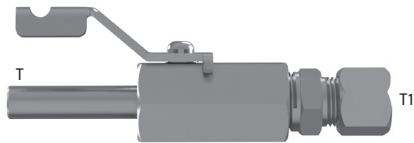

Part Number	T	T1
SSBV-6TUBE-6TF-316	3/8 TUBE	3/8 TF
SSBV-6TUBE-8TF-316	3/8 TUBE	1/2 TF

## Tube Stub x Straight or Tapered Thread

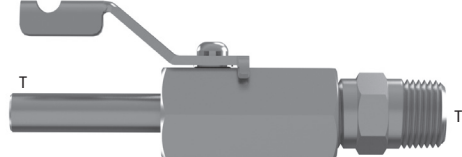

Part Number	T	T1(M)
SSBV-6TUBE-6-316	3/8 TUBE STUB	3/8 NPS
SSBV-6TUBE-6T-316	3/8 TUBE STUB	3/8 NPT

## Tube Fitting X 3/8" Reverse Bulkhead Thread

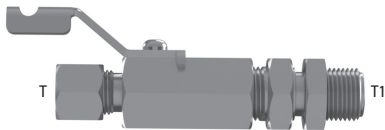

Part Number	T	T1(M)
SSBV-6TF-6RB-316	3/8 TF	3/8 NPS
SSBV-8TF-6RB-316	1/2 TF	3/8 NPS

## Cliplock



Part Number
SSBV-CLIPLOCK

Lockable assembly to prevent accidental handle actuation which can be used to lock the ball valve open or closed. This 3 piece assemble comes with Saddle Body, lanyard, and Locking Tab and can be added to any existing Hosco SSBV Ball Valve or supplied with new valves.



# SST Ball Valves SSBV Series Part Configurator

## Body End Connectors

Male Thread

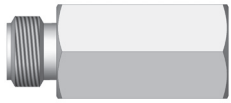

1/4"	3/8"
-4 (NPS)	-6 (NPS)
-4T (NPT)	-6T (NPT)
-4B (BSP)	-6B (BSP)
-4BT (BSPT)	-6BT (BSPT)

Tube Stub 17" Max  
1.5"/38mm STD



Metric	Fractional
-10MMTUBE	-6TUBE (3/8)
-12MMTUBE	-8TUBE (1/2)

Compression



Metric	Fractional
-8MMTF	-4TF (1/4)
-10MMTF	-6TF (3/8)
-12MMTF	-8TF (1/2)

## Fitting End Connectors

Male Thread



1/4"	3/8"
-4 (NPS)	-6 (NPS)
-4T (NPT)	-6T (NPT)
-4B (BSP)	-6B (BSP)
-4BT (BSPT)	-6BT (BSPT)

Female Thread

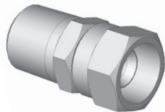

1/4"	3/8"
-4SN (NPS)	-6SN (NPS)
-4T(F) (NPT)	-6T(F) (NPT)
-4SNB (BSP)	-6SNB (BSP)
-4BT(F) (BSPT)	-6BT(F) (BSPT)

Tube Stub 17" Max  
1.5"/38mm STD

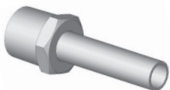

Metric	Fractional
-10MMTUBE	-6TUBE (3/8)
-12MMTUBE	-8TUBE (1/2)

Compression



Metric	Fractional
-8MMTF	-4TF (1/4)
-10MMTF	-6TF (3/8)
-12MMTF	-8TF (1/2)

Standard stainless steel ball valve.

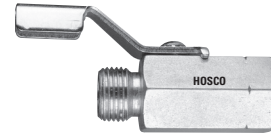

Sample of ordering:  
SSBV - X - X - 316  
Body End Fitting End

For non-standard configurations  
call: 248.912.1750  
or email: info@hosco.net

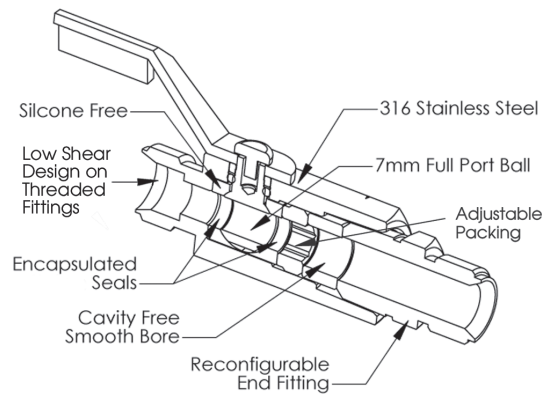

Bulkhead Compression

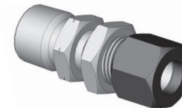

Metric	Fractional
-8MMBTF	-4BTF (1/4)
-10MMBTF	-6BTF (3/8)
-12MMBTF	-8BTF (1/2)

Reverse Bulkhead



Metric	Fractional
	-6RB (NPS)



# SST Ball Valves HBV Series Part Configurator

## Body End Connectors

Male Thread



1/4"	3/8"
-4 (NPS)	-6 (NPS)
-4T (NPT)	-6T (NPT)
-4B (BSP), PF •	-6B (BSP), PF •
-4BT (BSPT), PF •	-6BT (BSPT), PF

Tube Stub 17" Max  
1.5"/38mm STD



Metric	Fractional
-10MMTUBE •	-6TUBE (3/8) •
-12MMTUBE •	-8TUBE (1/2) •

Compression



Metric	Fractional
-10MMTF •	-6TF (3/8) •
-12MMTF	-8TF (1/2) •

## Fitting End Connectors

Male Thread

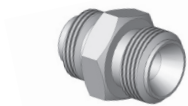

1/4"	3/8"
-4 (NPS)	-6 (NPS)
-4T (NPT) •	-6T (NPT)
-4B (BSP), PF •	-6B (BSP), PF
-4BT (BSPT), PT •	-6BT (BSPT), PT

Female Thread

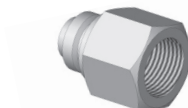

1/4"	3/8"
-4SN (NPS) •	-6SN (NPS)
-4T(F) (NPT)	-6T(F) (NPT)
-4SNB (BSP), PF •	-6SNB (BSP), PF
-4BT(F) (BSPT), PT	-6BT(F) (BSPT), PT

Tube Stub 17" Max  
1.5"/38mm STD



Metric	Fractional
-10MMTUBE •	-6TUBE (3/8) •
-12MMTUBE	-8TUBE (1/2) •

Compression



Metric	Fractional
-8MMTF •	-4TF (1/4) •
-10MMTF •	-6TF (3/8)
-12MMTF •	-8TF (1/2)

New HBV series ball valve  
1/2" shorter than typical ball valve

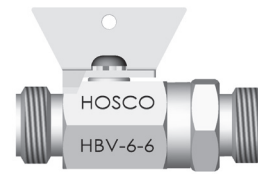

Sample of ordering:  
HBV - X - X - 316  
Body End Fitting End

For available configurations in HBV Series  
call: 248.912.1750  
or email: info@hosco.net

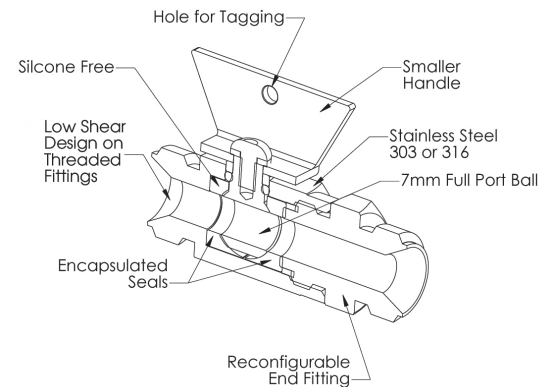

Bulkhead Compression

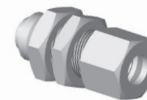

Metric	Fractional
-10MMBTF •	-6BTF (3/8) •
-12MMBTF •	-8BTF (1/2) •

Reverse Bulkhead



Metric	Fractional
	-6RB (NPS) •

• Indicates **Special Order**, not in stock.  
Pricing highly depended on quantity.





# H-Valve Assemblies

Male Straight x Bulkhead Tube Fitting

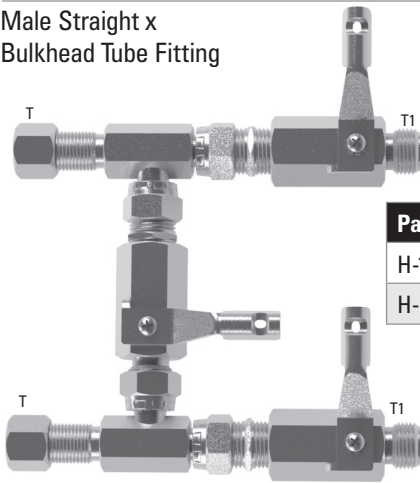

Part #	T	T1(M)
H-100A	3/8" BTF	3/8" NPS
H-200	1/2" BTF	3/8" NPS

Images are approx. 1/4 scale

Tube Fitting x Male Straight Reverse Bulkhead

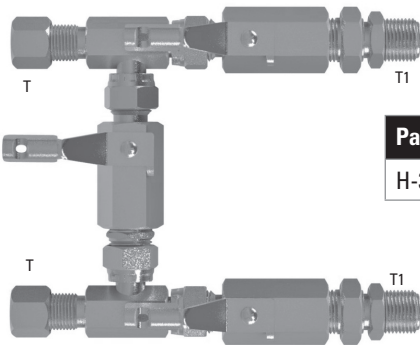

Part #	T	T1(M)
H-300	3/8" BTF	3/8" NPS

Hosco "H-Valve" assemblies are designed to provide an integral bypass to circulate paint or fluid properly during service time or maintenance interval periods. This eliminates the need for add on external hose jumpers or hard tube restrictor stations during service time or maintenance interval periods. There are many configurations available on the inlet and outlet compression connections (1/4", 3/8", 1/2", 8mm, 10mm, 12mm) and all in booth side connections are typically 3/8" NPS(M). The bulkhead wall mounted H-Valve assembly can be constructed to be operated from inside the spray zone (standard bulkhead models) or outside the spray zone (reverse bulkhead models).

## Feature and Benefits

### Complete Paint Station Assembly

- Saves assembly cost on site, ready to install and make connections to piping system and spray equipment

### SST Construction

- 304L/316 materials compatible with all coatings
- Long life

### Low Shear Design

- Large flow passageways minimize shear and coating degradation and subsequent pressure or flowrate losses

### Permanent Integral Bypass

- Safe bypass method even during "hot work" in booth area
- Immediately available for bypass when needed

# 3-Way Ball Valves



Female Tapered Pipe Thread

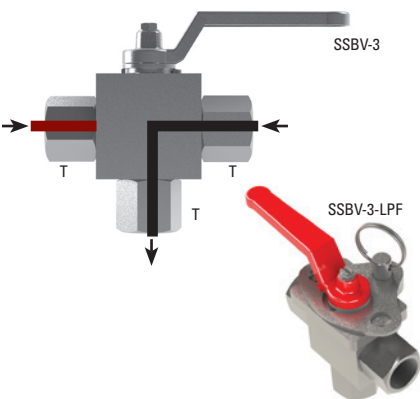

Part Number	T (F)
SSBV-3	3/8 NPT
SSBV-3-LPF	3/8" NPT with locking pin feature

Hosco 3 way Ball Valves are an excellent choice to provide safe switching from color to color or catalyst to solvent with no concern for cross contaminating, the "L" shaped ball provides two material inlets that are cavity free that feed to a common outlet at the bottom of the valve. When the handle is in the mid point between ports all inlet ports are shut off and there is no material being fed to the outlet. It is recommended to mount the 3 way ball valve vertically to facilitate easy draining and no agglomeration at the outlet, and Hosco provides an optional wall bracket to facilitate proper mounting. The valve is rated to 1000 PSI WP.

## Feature and Benefits

### SST Construction

- Compatible to coatings, solvents and adhesives
- Long life

### Cavity free Encapsulated inlet seals

- Prevents "dirt in paint" and agglomerations or crystallization of catalyst at inlet

### 3 position Valve design

- Material 1 "on", material 2 "on" or "all off" positions
- Impossible to cross contaminate

### Lots of accessories

- Bulkhead Mounting bracket available
- Many adapter fittings available to connect to any type of hose or tube input or outlet connections available



# HRS Manifolds Rail System

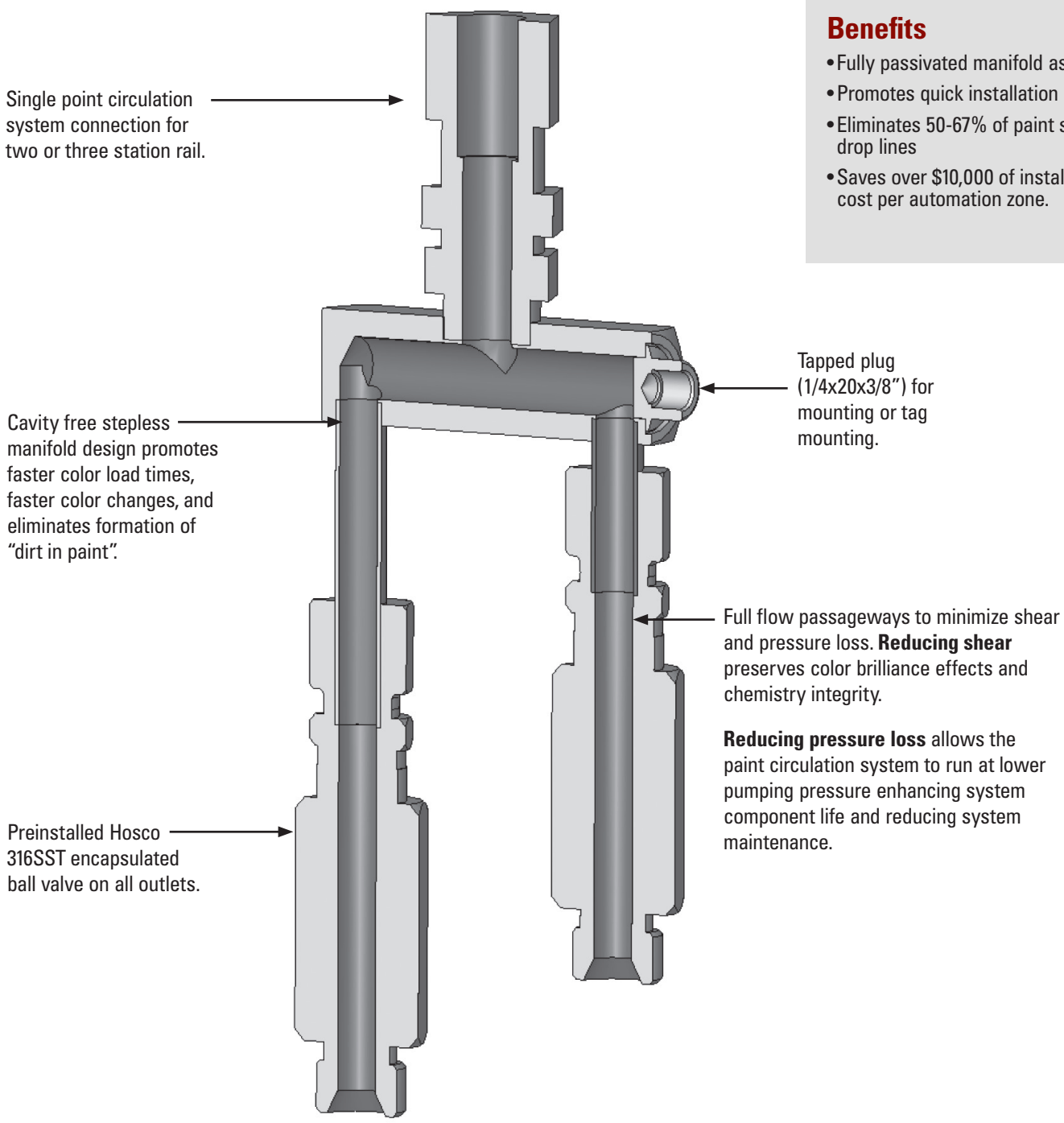

- ### Benefits
- Fully passivated manifold assembly
  - Promotes quick installation
  - Eliminates 50-67% of paint station drop lines
  - Saves over \$10,000 of installation cost per automation zone.

Two Outlet Manifold		Three Outlet Manifold	
HRS-200	1/2" bulkhead compression inlet x (2) 3/8" NPS(M) outlet ball valves (stepped at 1" & 2" for hose connection access in drop box)	HRS-300	5/8" bulkhead compression inlet x (3) 3/8" NPS(M) outlet ball valves (stepped at 1", 2" & 3" for hose connection access in drop box)
HRS-200L	Same as HRS200 except stepped at 3" & 4"	HRS-300L	Same as HRS300 except stepped at 4", 5" & 6"
HRS-201	1/2" Compression inlet x (2) 3/8" NPS (M) reverse bulkhead outlet ball valves	HRS-301	5/8" compression inlet x 3 (3) 3/8" NPS(M) reverse bulkhead outlet ball valves



# HRS Manifolds Rail System continued

## Automation Paint Station Ball Valve Assemblies

### 2 Station Configuration

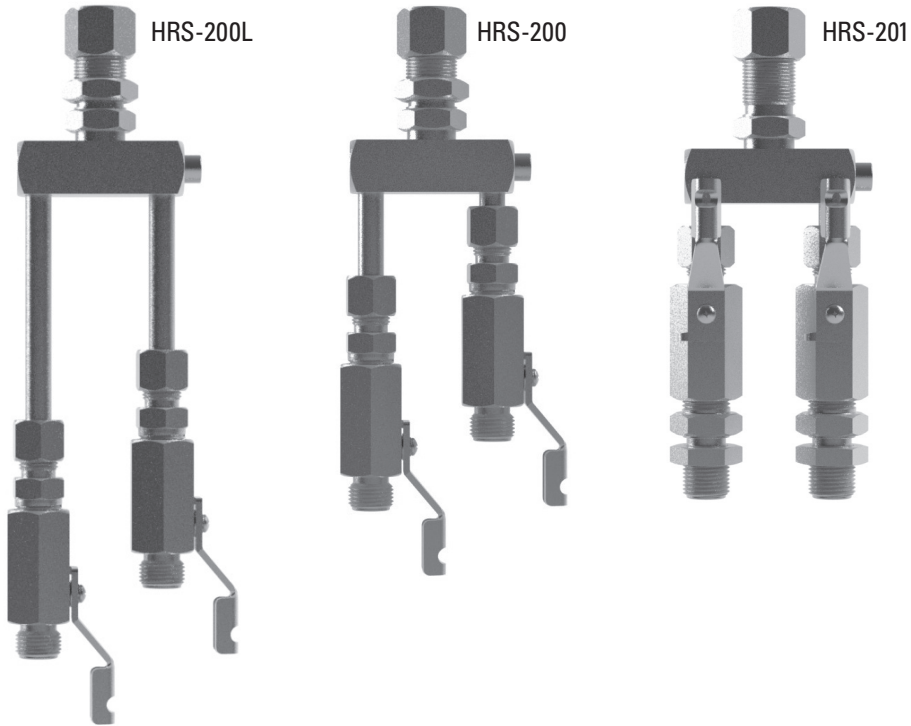

### Features

Hosco "HRS" rail system paint station drop assemblies are cavity free, smooth bore and provide quick, economical installation for robotic rail stations or fixed automation systems.

The system is made with up to six stepped length ball valve designs to facilitate compact paint station construction as shown below.

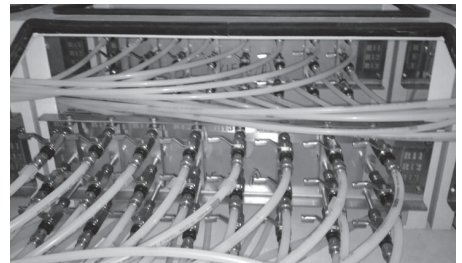

### 3 Station Configuration

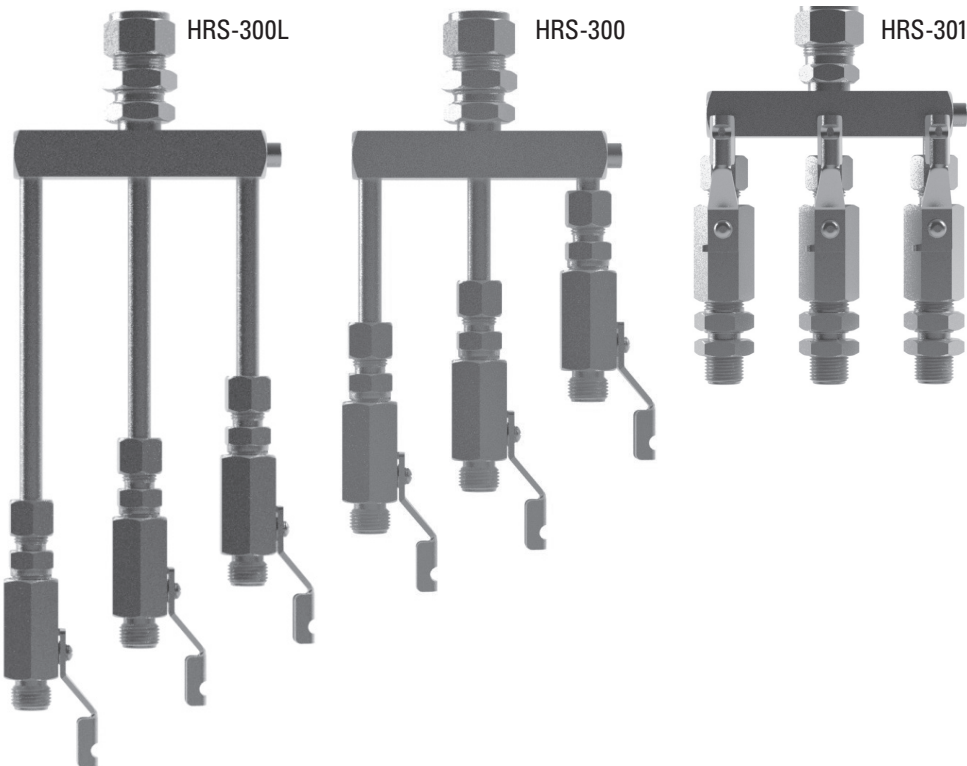



# Swivels

## Female Straight x Male Straight



Part Number	T(F)	T1(M)
4SN-4SW	1/4 NPS	1/4 NPS
4SNB-4SW	1/4 BSP	1/4 NPS
6SN-6SW	3/8 NPS	3/8 NPS
6SN-6SWB	3/8 NPS	3/8 BSP
6SNB-6SW	3/8 BSP	3/8 NPS
6SNB-6SWB	3/8 BSP	3/8 BSP

Hosco in-line fluid swivels provide protection to the operator by reducing hose twists or stress during the tool use. It is also frequently used to eliminate hose failures in robotic or rotary machine stations. The swivels are rated to 2500 PSI WP so they can be used on low and medium pressure applications of coatings, adhesives and even some high viscosity sealants or mastics, and will work on non-fluid applications too.

### Feature and Benefits

#### 2500 PSI Working Pressure

- Compatible with a wide range of applicators and application pressure

#### 304/316 SST Construction

- Compatible with all coatings and adhesive materials known
- SST construction provides long service life

#### Precision Design/Operation

- Ball bearing swivel design for smooth and effortless operation

#### Smooth Bore & Cavity Free

- Smooth bore (0.300") reduces shear and pressure loss even with high viscosity fluids
- Cavity free insures quick and easy flushing or cleaning

# Check Valves



## Male to Female Flow

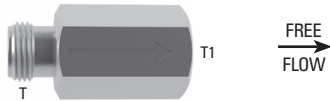

Part Number	T (M)	T1 (F)
SSCV-6	3/8 NPS	3/8 NPT
SSCV-6B	3/8 BSP	3/8 NPT



Part Number	T (M)	T1 (F)
6SN-6CV	3/8 NPS	3/8 NPS



Part Number	T (M)	T1 (F)
SSCV-6T	3/8 NPT	3/8 NPT
SSCV-6BT	3/8 NPT	3/8 BSPT

Hosco SSCV series and 6CV series Stainless Steel check valves provide compact solutions for preventing cross contamination or back flow in piping or hose/tube system applications. The SSCV series is most commonly applied in piping systems and is based on a "ball & seat" style design with cracking pressure at 2psi and flow ranges to 2000 cc/min (depending on viscosity and inlet pressures). The CV series is primarily applied near color changers or valve manifolds and is a "poppet style" check valve design with a cracking pressure of less than 1 psi and flow ranges up to 1000 cc/min (depending on viscosity and inlet pressures).

### Feature and Benefits

#### Compact Design

- Easily installed in piping or hose/tube systems

#### Low Cracking Pressures

- Reacts immediately to small changes in pressure upstream or downstream of check valve to protect material integrity

#### Stainless Steel Construction

- Suitable for use in all coatings & solvent materials

#### Multiple Configurations

- NPT, BSPT(PT), NPS, BSPP(PF) connections available

## Female to Male Reverse Flow

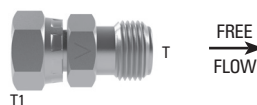

Part Number	T (M)	T1 (F)
6CV-6SN	3/8 NPS	3/8 NPS



# Circulation Adapters

Female Straight x Male Straight



Part Number	T(F)	T1(M)
RY-4-312	3/8 NPS	1/4 NPS
RY-6-312	3/8 NPS	3/8 NPS
RY-6B-312	3/8 BSP	3/8 BSP

Female Straight x Male Straight

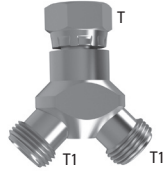

Part Number	T(F)	T1(M)
RY-4Y-312	3/8 NPS	1/4 NPS
RY-4YB-312	3/8 BSP	1/4 BSP
RY-6Y-312	3/8 NPS	3/8 NPS
RY-6Y-312-B	3/8 BSP	3/8 BSP

Female Straight x Male Straight

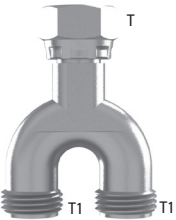

Part Number	T(F)	T1(M)
HCU-6	3/8 NPS	3/8 NPS
HCU-6B	3/8 BSP	3/8 BSP

Female Straight x Male Straight

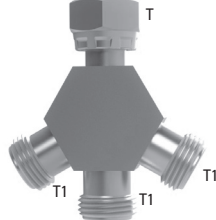

Part Number	T(F)	T1(M)
6SN-6-6-6	3/8 NPS	3/8 NPS

Female Straight x Tube Fitting

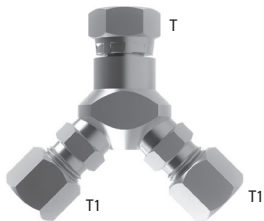

Part Number	T(F)	T1
RY-6TFY-312	3/8 NPS	3/8 TF

Tube Fitting x Tube Fitting

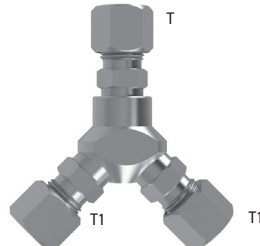

Part Number	T	T1
RY-6TF-6TF-6TF	3/8 TF	3/8 TF
RY-8TF-6TF-6TF	1/2 TF	3/8 TF
RY-8TF-8TF-8TF	1/2 TF	1/2 TF

Tube Fitting x Male Straight

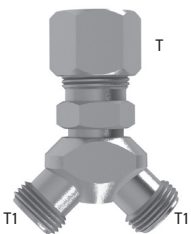

Part Number	T	T1
RY-6TF-6-6	3/8 TF	3/8 NPS
RY-8TF-6-6	1/2 TF	3/8 NPS

Female Straight x Male Straight

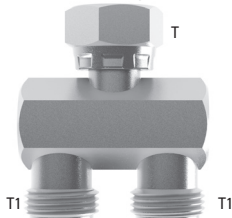

Part Number	T(F)	T1
RY-6-187-ST	3/8 NPS	3/8 NPS

Hosco Circulation Adapters are available in a wide variety of configurations, with as many as three outlets with "in line", 45 and 90 degree angle connection points. All of the Circulation Adapters are constructed using the "smooth bore, cavity free" features and have large bore circulation flow passageways to minimize shear and resultant pressure loss. Connection points are 3/8" NPS(M) or (F) 1/4" or 3/8" NPT(M) or (F), 3/8" -1/2" -5/8" Compression style, or 3/8" -1/2" -5/8" -3/4" OD Tube Stub configurations depending on the application requirements. The typical application of these products is for splitting a single paint feed or return line to feed two or even three applicators, providing a single solvent supply or other fluids to multiple points of use in the application station, or creating a restrictor station or "bleed off" to control flowrate at the station.

## Feature and Benefits

### Multiple Configurations

- In-line, 45 or 90 degree inlet/outlet(s) versions
- 1/4", 3/8", 1/2", 5/8" and 3/4" inlet/outlet sizes
- NPT, NPS, Compression and Tube Stub connection points
- 2, 3 and even 4 outlet configurations

### SST Construction

- Long life

### Unique Manufacturing Processes

- Unique processing provides chemical free passivation and absolutely clean product for installation

### Cavity Free & Smooth Bore Design

- To minimize material pack out or "dirt in paint" and provide easy to clean and flush components
- Large flow passageways minimize shear and coating degradation and subsequent pressure or flowrate losses



# SST Fittings and Adaptors

## Straights Thread x Thread

Male Straight x Male Straight

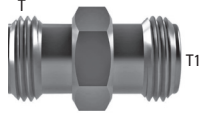

Part Number	T (M)	T1 (M)
4-4	1/4 NPS	1/4 NPS
4B-4B	1/4 BSP	1/4 BSP
4-4B	1/4 NPS	1/4 BSP
4-6	1/4 NPS	3/8 NPS
4-6B	1/4 NPS	3/8 BSP
4B-6	1/4 BSP	3/8 NPS
4B-6B	1/4 BSP	3/8 BSP
6-6	3/8 NPS	3/8 NPS
6B-6B	3/8 BSP	3/8 BSP
6-6B	3/8 NPS	3/8 BSP

Male Tapered x Male Tapered

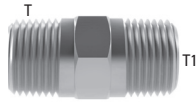

Part Number	T (M)	T1 (M)
2T-2T	1/8 NPT	1/8 NPT
2T-4T	1/8 NPT	1/4 NPT
4T-4T	1/4 NPT	1/4 NPT
6T-4T	3/8 NPT	1/4 NPT
6T-6T	3/8 NPT	3/8 NPT
8T-4T	1/2 NPT	1/4 NPT
8T-6T	1/2 NPT	3/8 NPT
8T-8T	1/2 NPT	1/2 NPT

Male Tapered x Male Straight

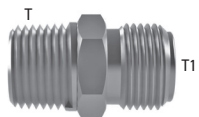

Part Number	T (M)	T1 (M)
2T-4	1/8 NPT	1/4 NPS
2BT-6	1/8 BSPT	3/8 NPS
2T-6	1/8 NPT	3/8 NPS
2T-6B	1/8 NPT	3/8 BSP
4T-4	1/4 NPT	1/4 NPS
4T-4B	1/4 NPT	1/4 BSP
4T-6	1/4 NPT	3/8 NPS
4T-6B	1/4 NPT	3/8 BSP
6T-4	3/8 NPT	1/4 NPS
6BT-4	3/8 BSPT	1/4 NPS
6T-4B	3/8 NPT	1/4 BSP
6T-6	3/8 NPT	3/8 NPS
6T-6B	3/8 NPT	3/8 BSP
8T-6	1/2 NPT	3/8 NPS
8T-6B	1/2 NPT	3/8 BSP

Male Straight x Bulkhead

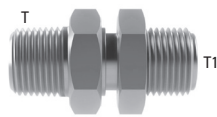

Part #	T (M)	T1 (M)	Bulkhead Hole Size
4-4RB	1/4 NPS	1/4 NPS	17/32 (13.5) mm
4B-4RBB	1/4 BSP	1/4 BSP	17/32 (13.5) mm
6-6RB	3/8 NPS	3/8 NPS	11/16 (17.5) mm
6B-6RBB	3/8 BSP	3/8 BSP	11/16 (17.5) mm

Female Straight x Bulkhead



Part #	T (F)	T1	Bulkhead Hole Size
6SN-6RB	3/8 NPS	3/8 NPS	11/16 (17.5) mm
6SNB-6RB	3/8 BSP	3/8 NPS	11/16 (17.5) mm

Hosco Fittings and Adaptors are available in a wide variety of configurations with "in-line", 45 and 90 degree angle connection points. All of the Fittings and Adaptors are constructed using the "smooth bore, cavity free" features and have large bore circulation flow passageways as standard to minimize shear and resultant pressure loss. Special manufacturing techniques also provide cavity free operation to prevent material "pack out" or contamination and easy to flush and clean in place. Connection points are NPT Male or Female ends from 1/8" to 1/2", NPS Male in 1/8" to 3/8" or Female (Swivel Nut) in 1/4" or 3/8", JIC (M) ends from 1/8" thru 3/8", Compression ends from 1/4" thru 5/8" (10mm, 12mm, 14mm, 16mm, 18mm plus DIN style in 13mm and 15mm) and Tube Stub ends in 1/4", 5/16", 3/8" or 1/2" (10mm, 12mm, 14mm, 16mm). In addition, there are many bulkhead versions and some reverse bulkhead versions as well.

## Feature and Benefits

### Multiple Configurations

- In-line, 45 or 90 degree inlet/outlet(s) versions
- 1/8", 1/4", 3/8", 1/2", and 5/8" inlet/outlet sizes (10mm, 12mm, 14mm, 16mm, and DIN style 13mm and 15mm)
- NPT (BSPT/PT), NPS (BSPP/PF), JIC(M), Compression and Tube Stub connection points
- Bulkhead and Reverse Bulkhead options on some sizes

### SST Construction

- Long life

### Cavity Free & Smooth Bore Design

- To minimize material pack out or "dirt in paint" and provide easy to clean and flush components

### Low Shear Design

- Large flow passageways minimize shear and coating degradation and subsequent pressure or flowrate losses



# SST Fittings and Adaptors continued

## Straights Thread x Thread continued

Male Tapered x Bulkhead



Part #	T (M)	T1 (M)	Bulkhead Hole Size
4T-4RB	1/4 NPT	1/4 NPS	17/32 (13.5) mm
6T-4RB	3/8 NPT	1/4 NPS	17/32 (13.5) mm
6T-6RB	3/8 NPT	3/8 NPS	11/16 (17.5) mm

Male Straight x Male Flare

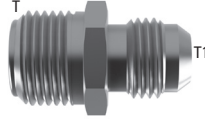

Part Number	T (M)	T1 (M)
4-4JIC	1/4 NPS	1/4 JIC
4B-4JIC	1/4 BSP	1/4 JIC
4-6JIC	1/4 NPS	3/8 JIC
6-4JIC	3/8 NPS	1/4 JIC
6-6JIC	3/8 NPS	3/8 JIC

Female Straight x Male Flare

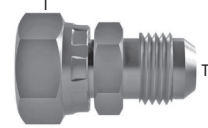

Part Number	T (F)	T1 (M)
4SN-4JIC	1/4 NPS	1/4 JIC
4SN-6JIC	1/4 NPS	3/8 JIC
6SN-6JIC	3/8 NPS	3/8 JIC

Female Straight x Female Straight



Part Number	T (F)	T1 (F)
4SN-4SN	1/4 NPS	1/4 NPS
4SNB-4SNB	1/4 BSP	1/4 BSP
4SN-6SN	1/4 NPS	3/8 NPS
4SNB-6SN	1/4 BSP	3/8 NPS
4SNB-6SNB	1/4 BSP	3/8 BSP
6SN-6SN	3/8 NPS	3/8 NPS
6SNB-6SNB	3/8 BSP	3/8 BSP

Female Straight x Male Tapered

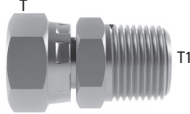

Part Number	T (F)	T1 (M)
4SN-2T	1/4 NPS	1/8 NPT
4SN-4T	1/4 NPS	1/4 NPT
4SN-4BT	1/4 NPS	1/4 BSPT
4SN-6T	1/4 NPS	3/8 NPT
4SNB-6T	1/4 BSP	3/8 NPT
6SN-2T	3/8 NPS	1/8 NPT
6SN-4T	3/8 NPS	1/4 NPT
6SNB-4BT	3/8 BSP	1/4 BSPT
6SN-6T	3/8 NPS	3/8 NPT
6SNB-6T	3/8 BSP	3/8 NPT
6SN-6BT	3/8 NPS	3/8 BSPT
6SN-8T	3/8 NPS	1/2 NPT

Female Straight x Male Straight



Part Number	T (F)	T1 (M)
4SN-4	1/4 NPS	1/4 NPS
4SN-4B	1/4 NPS	1/4 BSP
4SNB-4	1/4 BSP	1/4 NPS
4SNB-4B	1/4 BSP	1/4 BSP
4SN-6	1/4 NPS	3/8 NPS
4SN-6B	1/4 NPS	3/8 BSP
4SNB-6B	1/4 BSP	3/8 BSP
6SN-4	3/8 NPS	1/4 NPS
6SN-4B	3/8 NPS	1/4 BSP
6SNB-4	3/8 BSP	1/4 NPS
6SNB-4B	3/8 BSP	1/4 BSP
6SN-6	3/8 NPS	3/8 NPS
6SN-6B	3/8 NPS	3/8 BSP

Female Straight x Female Tapered

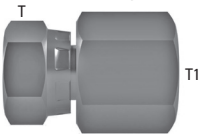

Part Number	T (F)	T1 (F)
4SN-4T(F)	1/4 NPS	1/4 NPT
4SNB-4T(F)	1/4 BSP	1/4 NPT
6SN-2T(F)	3/8 NPS	1/8 NPT
6SNB-2T(F)	3/8 BSP	1/8 NPT
6SN-4T(F)	3/8 NPS	1/4 NPT
6SNB-4T(F)	3/8 BSP	1/4 NPT
6SN-6T(F)	3/8 NPS	3/8 NPT
6SNB-6T(F)	3/8 BSP	3/8 NPT

Male Straight x Female Tapered

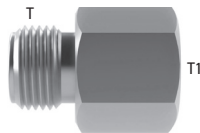

Part Number	T (M)	T1 (F)
4-4T(F)	1/4 NPS	1/4 NPT
4B-4T(F)	1/4 BSP	1/4 NPT
6-2T(F)	3/8 NPS	1/8 NPT
6-4T(F)	3/8 NPS	1/4 NPT
6-6T(F)	3/8 NPS	3/8 NPT
6B-4T(F)	3/8 BSP	1/4 NPT



# SST Fittings and Adaptors continued

## Straights Thread x Tube

Male Straight x Tube Fitting

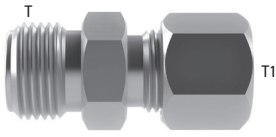

Part Number	T(M)	T1
4-6TF	1/4 NPS	3/8 TF
6-6TF	3/8 NPS	3/8 TF
6-8TF	3/8 NPS	1/2 TF

Male Straight x Tube Stub



Part Number	T (M)	T1
6TUBE-4	1/4 NPS	3/8 TUBE
6-6TUBE	3/8 NPS	3/8 TUBE
6-8TUBE	3/8 NPS	1/2 TUBE
6-10MMTUBE	3/8 NPS	10MM TUBE
6-12MMTUBE	3/8 NPS	12 MM TUBE

Female Straight x Tube Fitting



Part Number	T (F)	T1
4SN-4TF	1/4 NPS	1/4 TF
6SN-4TF	3/8 NPS	1/4 TF
6SN-6TF	3/8 NPS	3/8 TF
6SN-8TF	3/8 NPS	1/2 TF
6SNB-6TF	3/8 BSP	3/8 TF
6SNB-8TF	3/8 BSP	1/2 TF
6SN-10MMTF	3/8 NPS	10MM TF
6SN-12MMTF	3/8 NPS	12MM TF

Male Straight x Bulkhead

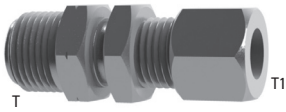

Part Number	T(M)	T1	Bulkhead Hole Size
4-6BTF	1/4 NPS	3/8 BTF	37/64
6-6BTF	3/8 NPS	3/8 BTF	37/64

Tube Fitting x Reverse Bulkhead

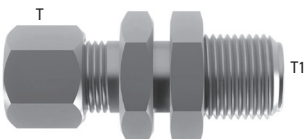

Part Number	T	T1(M)	Bulkhead Hole Size
6TF-6RB	3/8 TF	3/8 NPS	11/16" (17.5) mm
8TF-6RB	1/2 TF	3/8 NPS	11/16" (17.5) mm

Female Straight x Bulkhead

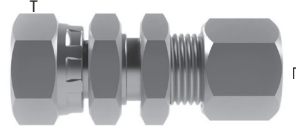

Part Number	T(F)	T1	Bulkhead Hole Size
6SN-6BTF	3/8 NPS	3/8 BTF	37/64" (15 mm)
6SN-8BTF	3/8 NPS	1/2 BTF	49/64" (19.5 mm)
6SN-10MMBTF	3/8 NPS	10MM BTF	16.5 mm
6SN-12MMBTF	3/8 NPS	12MM BTF	18.5 mm

## Straights BSPP

Male Straight x Male British Straight



Part Number	T(M)	T1(M)
4-2BSP	1/4 NPS	1/8 BSPP
4-2BSPP	1/4 NPS	1/8 BSPP W/ 30 DEG SEAT
4-4BSP	1/4 NPS	1/4 BSPP
4-4BSPP	1/4 NPS	1/4 BSPP W/30 DEG SEAT
6-2BSP	3/8 NPS	1/8 BSPP
6-4BSP-IGUN	3/8 NPS	1/4 BSPP IGUN

PLUG

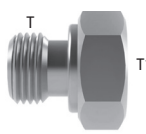

PLUG	T(M)	T1
2BSP-PLUG	1/8 BSPP	PLUG





# SST Fittings and Adaptors continued

## Elbows Thread x Thread

Male Straight x Male Straight 45°

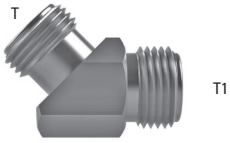

Part Number	T (M)	T1 (M)
6-6-45	3/8 NPS	3/8 NPS

Male Straight x Male Straight 90°

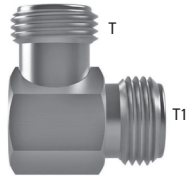

Part Number	T (M)	T1 (M)
4-4-90	1/4 NPS	1/4 NPS
4-4B-90	1/4 NPS	1/4 BSP
4B-4B-90	1/4 BSP	1/4 BSP
6-6-90	3/8 NPS	3/8 NPS

Male Tapered x Male Straight 45°

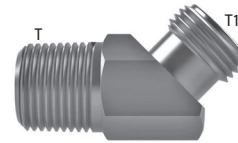

Part Number	T (M)	T1 (M)
2T-6-45	1/8 NPT	3/8 NPS
4T-6-45	1/4 NPT	3/8 NPS
6T-6-45	3/8 NPT	3/8 NPS

Male Tapered x Male Straight 90°

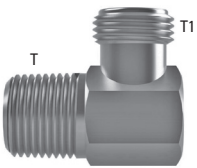

Part Number	T (M)	T1 (M)
2T-4-90	1/8 NPT	1/4 NPS
2T-4B-90	1/8 NPT	1/4 BSP
2T-6-90	1/8 NPT	3/8 NPS
4T-4-90	1/4 NPT	1/4 NPS
4T-4B-90	1/4 NPT	1/4 BSP
4T-6-90	1/4 NPT	3/8 NPS
6T-4-90	3/8 NPT	1/4 NPS
6T-6-90	3/8 NPT	3/8 NPS

Female Straight x Male Straight 90°

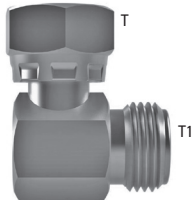

Part Number	T(F)	T1(M)
4SN-4-90	1/4 NPS	1/4 NPS
4SN-6-90	1/4 NPS	3/8 NPS
4SNB-4B-90	1/4 BSP	1/4 BSP
6SN-4-90	3/8 NPS	1/4 NPS
6SN-6-90	3/8 NPS	3/8 NPS
6SN-6B-90	3/8 NPS	3/8 BSP
6SNB-6B-90	3/8 BSP	3/8 BSP

Female Straight x Male Straight 45°

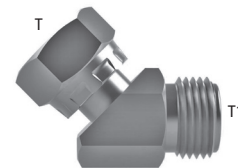

Part Number	T(F)	T1(M)
4SN-4-45	1/4 NPS	1/4 NPS
6SN-6-45	3/8 NPS	3/8 NPS
6SN-6B-45	3/8 NPS	3/8 BSP

Female Straight x Male Tapered 90°

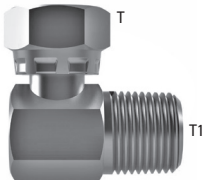

Part Number	T(F)	T1(M)
4SN-4T-90	1/4 NPS	1/4 NPT
4SN-6T-90	1/4 NPS	3/8 NPT
6SN-4T-90	3/8 NPS	1/4 NPT
6SN-6T-90	3/8 NPS	3/8 NPT



# SST Fittings and Adaptors continued

## Elbows Thread x Tube

Male Straight x Tube Fitting 90°

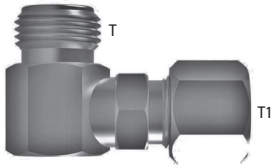

Part Number	T (M)	T1
6-6TF-90	3/8 NPS	3/8 TF
6-8TF-90	3/8 NPS	1/2 TF

Female Straight x Tube Fitting 90°

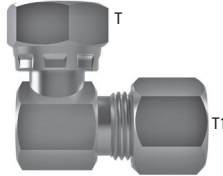

Part Number	T (F)	T1
6SN-10MMTF-90	3/8 NPS	10MM TF
6SN-6TF-90	3/8 NPS	3/8 TF
6SN-8TF-90	3/8 NPS	1/2 TF

Male Straight x Bulkhead 90°

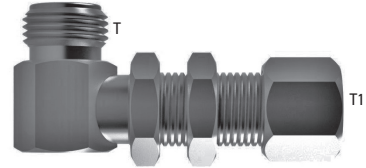

Part Number	T (M)	T1
6-6BTF-90	3/8 NPS	3/8 BTF

Female Straight x Bulkhead 90°

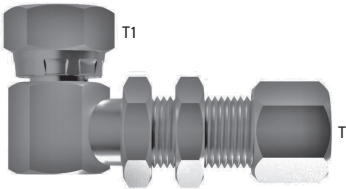

Part Number	T (F)	T1
6SN-10MMBTF-90	3/8 NPS	3/8 BTF
6SN-6BTF-90	3/8 NPS	3/8 BTF

Male Straight x Bulkhead 45°

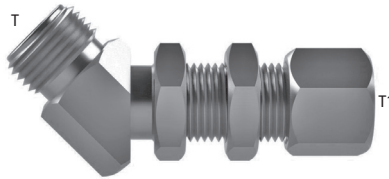

Part Number	T (M)	T1
6-6BTF-45	3/8 NPS	3/8 BTF

Female Straight x Bulkhead 45°

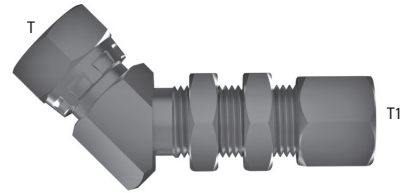

Part Number	T (F)	T1
6SN-6BTF-45	3/8 NPS	3/8 BTF

## Caps

Female Straight



Part Number	T (F)
4-CAP	1/4 NPS
4B-CAP	1/4 BSP
6-CAP	3/8 NPS
6B-CAP	3/8 BSP

## Plugs

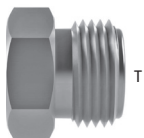

Male Straight

Part Number	T (M)
4-PLUG	1/4 NPS
6-PLUG	3/8 NPS

Male Tapered

Part Number	T (M)
4T-PLUG	1/4 NPT

## Brand Specific

Male Straight x DR-1

(for inlet to Ransburg DR-1 family of fluid regulators)

Part Number	T	T1
DR1-2-4	1/4 NPS	DR1 Inlet

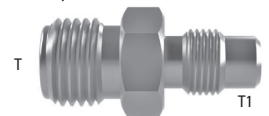

Short AW Fitting Male Straight x Male British Straight

Part Number	T	T1
4-2BSP-AWS	1/4 NPS	1/8 BSP
4-4BSP-AWS	1/4 NPS	1/4 BSP

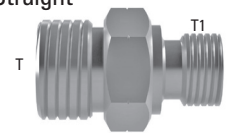

Long AW Fitting Male Straight x Male British Straight

Part Number	T	T1
4-2BSP-AWL	1/4 NPS	1/8 BSP



Part Number	T	T1
4-2BSP-AWL-A	1/4 NPS	1/8 BSP





# Tees

## Male Straight x Male Straight x Male Straight



Part Number	T (M)	T1 (M)	T2 (M)
6-6-6	3/8 NPS	3/8 NPS	3/8 NPS
6B-6B-6B	3/8 BSP	3/8 BSP	3/8 BSP

## Male Straight x Male Straight x Female Straight

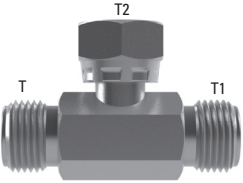

Part Number	T (M)	T1 (M)	T2 (F)
6-6-6SN	3/8 NPS	3/8 NPS	3/8 NPS

## Female Straight x Female Straight x Female Straight

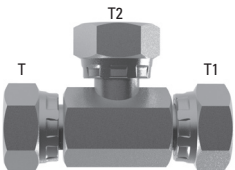

Part Number	T (F)	T1 (F)	T2 (F)
6SN-6SN-6SN	3/8 NPS	3/8 NPS	3/8 NPS
6SNB-6SNB-6SNB	3/8 BSP	3/8 BSP	3/8 BSP

## Female Straight x Male Straight x Male Straight

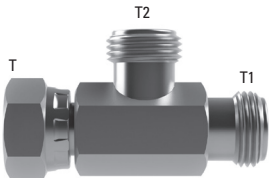

Part Number	T (F)	T1 (M)	T2 (M)
6SN-6-6	3/8 NPS	3/8 NPS	3/8 NPS
6SNB-6B-6B	3/8 BSP	3/8 BSP	3/8 BSP

## Female Straight x Tube Fitting x Female Tapered

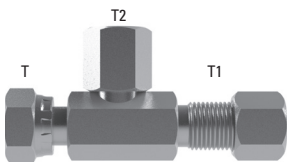

Part Number	T (F)	T1	T2 (F)
6SN-6TF-4T(F)	3/8 NPS	3/8 TF	1/4 NPT

## Male Straight X Male Straight X Male Tapered

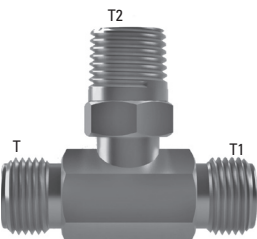

Part Number	T (M)	T1 (M)	T2 (M)
6-6-4T	3/8NPS	3/8NPS	1/4 NPT
6-6-6T	3/8NPS	3/8NPS	3/8 NPT

Hosco compact Tees product family is designed for use in piping systems to provide sampling or monitoring ports, or to provide multiple inlet or outlet ports to name a few uses. The Tees are available in standard tee and bulkhead tee configurations, and generally in 1/4" or 3/8" NPS/BSPP (PF) male or female swivel nut, 1/4" or 3/8" NPT/BSPT (PT), 3/8" or 1/2" Tube Stubs or metric equivalents, 3/8" TF or BTF compression or bulkhead compression (or metric equivalents) styles, or JIC style. Our flexible designs allow any combination of these to meet the application.

## Feature and Benefits

### Multiple Configurations

- NPT/BSPT (PT), NPS/BSPP (PF), Compression, JIC, and Tube Stub connection points

### SST Construction

- Long life

### Unique Manufacturing Processes

- Unique processing provides chemical free passivation and absolutely clean product for installation

### Cavity Free & Smooth Bore Design

- To minimize material pack out or "dirt in paint" and provide easy to clean and flush components

### Low Shear Design

- Large flow passageways minimize shear and coating degradation and subsequent pressure or flowrate losses

# Tees continued

# Pressure Gauge

**SILICONE  
CERTIFIED  
FREE**

Male Straight X Male Straight X Female Tapered

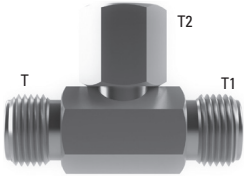

Part Number	T (M)	T1 (M)	T2 (F)
6-6-4T(F)	3/8 NPS	3/8 NPS	1/4 NPT

Female Straight X Male Straight X Male Tapered

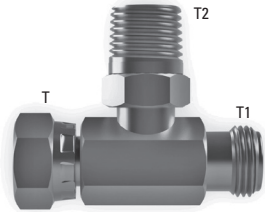

Part Number	T (F)	T1 (M)	T2 (M)
6SN-6-4T	3/8 NPS	3/8 NPS	3/8 NPT
6SN-6-6T	3/8 NPS	3/8 NPS	3/8 NPT

Female Straight X Male Straight X Female Straight

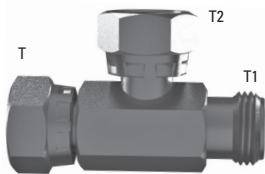

Part Number	T (F)	T1 (M)	T2 (F)
6SN-6-4SN	3/8 NPS	3/8 NPS	1/4NPS
6SN-6-6SN	3/8 NPS	3/8 NPS	3/8 NPS
6SNB-6B-6SNB	3/8 BSP	3/8 BSP	3/8 BSP

Female Straight X Female Straight X Male Straight

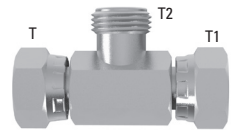

Part Number	T (F)	T1 (F)	T2 (M)
6SN-6SN-6	3/8 NPS	3/8 NPS	3/8 NPS

Female Straight X Bulkhead Tube Fitting X Female Straight

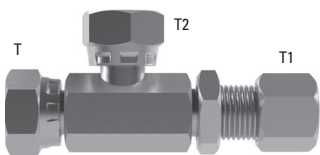

Part Number	T (F)	T1	T2 (F)
6SN-6BTF-6SN	3/8 NPS	3/8 BTF	3/8 NPS

Tube x Tube

Part Number	T	T1
HY-8-6-6	1/2 OD	3/8 OD
HY-10-8-8	5/8 OD	1/2 OD
HY-12-8-8	3/4 OD	1/2 OD

Image is approx. 1/4 scale

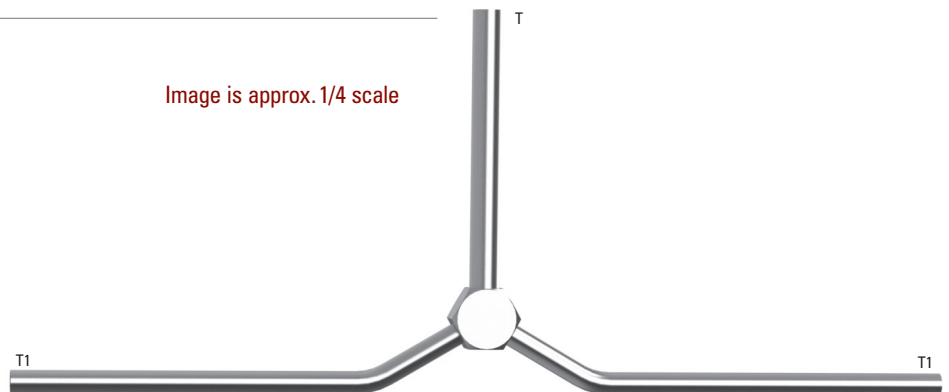

Part Number	T
PG-300-4T	1/4" NPT (M)
PG-300-4T(F)	1/4" NPT (F)
PG-200-4T	1/4" NPT (M)
PG-200-4T(F)	1/4" NPT (F)
PG-160-4T	1/4" NPT (M)
PG-160-4T(F)	1/4" NPT (F)

## Features

- 1/4" NPT(M) or (F) 316 SST
- Top mount or back mount
- 0-160 PSI (0-11 BAR) or 0-200 PSI (0-14 BAR) or 0-300 PSI (0-21 BAR)
- 2-1/2" gauge face dia.
- Glycerine filled
- Glass face



# Compression Fittings — Fractional Inch

## Male Connector



Part Number	Description
2T-4TF	1/8" NPT(M) x 1/4" TF
4T-4TF	1/4" NPT(M) x 1/4" TF
6T-4TF	3/8" NPT(M) x 1/4" TF
8T-4TF	1/2" NPT(M) x 1/4" TF
2T-6TF	1/8" NPT(M) x 3/8" TF
4T-6TF	1/4" NPT(M) x 3/8" TF
6T-6TF	3/8" NPT(M) x 3/8" TF
8T-6TF	1/2" NPT(M) x 3/8" TF
4T-8TF	1/4" NPT(M) x 1/2" TF
6T-8TF	3/8" NPT(M) x 1/2" TF
8T-8TF	1/2" NPT(M) x 1/2" TF
8T-10TF	1/2" NPT(M) x 5/8" TF
8T-12TF	1/2" NPT(M) x 3/4" TF
12T-10TF	3/4" NPT(M) x 5/8" TF
12T-12TF	3/4" NPT(M) x 3/4" TF
12T-16TF	3/4" NPT(M) x 1" TF
16T-16TF	1" NPT(M) x 1" TF
20T-20TF	1 1/4" NPT(M) x 1 1/4" TF
24T-24TF	1 1/2" NPT(M) x 1 1/2" TF
32T-32TF	2" NPT(M) x 2" TF

## Male 90° Elbow



Part Number	Description
2T-4TF-90	1/8" NPT(M) x 1/4" TF 90
4T-4TF-90	1/4" NPT(M) x 1/4" TF 90
6T-4TF-90	3/8" NPT(M) x 1/4" TF 90
8T-4TF-90	1/2" NPT(M) x 1/4" TF 90
2T-6TF-90	1/8" NPT(M) x 3/8" TF 90
4T-6TF-90	1/4" NPT(M) x 3/8" TF 90
6T-6TF-90	3/8" NPT(M) x 3/8" TF 90
8T-6TF-90	1/2" NPT(M) x 3/8" TF 90
4T-8TF-90	1/4" NPT(M) x 1/2" TF 90
6T-8TF-90	3/8" NPT(M) x 1/2" TF 90
8T-8TF-90	1/2" NPT(M) x 1/2" TF 90
8T-10TF-90	1/2" NPT(M) x 5/8" TF 90
8T-12TF-90	1/2" NPT(M) x 3/4" TF 90
12T-10TF-90	3/4" NPT(M) x 5/8" TF 90
12T-12TF-90	3/4" NPT(M) x 3/4" TF 90
12T-16TF-90	3/4" NPT(M) x 1" TF 90
16T-16TF-90	1" NPT(M) x 1" TF 90
16T-20TF-90	1" NPT(M) x 1 1/4" TF 90
20T-20TF-90	1 1/4" NPT(M) x 1 1/4" TF 90
24T-24TF-90	1 1/2" NPT(M) x 1 1/2" TF 90
32T-32TF-90	2" NPT(M) x 2" TF 90

Hosco provides the highest quality 316 Stainless Steel Compression & Instrumentation Fittings for installation into paint and coating applications. These compression tube fittings have heat code traceability and our quality raw materials come from US, France, and Italy. Third party testing from TUV proves our intermixability with the other industry leaders. Hosco can offer technical assistance and training on these fittings which are fully gaugeable with the same installation and remake instructions as the other top tier suppliers of these two ferrule compression fittings.

### Feature and Benefits

#### Wide Array of Sizes/Configurations

- Availability of all known Paint Circulation design connections for SST Paint Circ Systems

#### Local Inventory Commitment

- Able to supply from inventory and maintain a safety stock of unusual sizes used in Paint Circ System designs

#### Custom Assemblies with Hosco's Core Product Lines

- Hosco can "kit up" compression fittings, ball valves, hoses and fittings needed to reduce prep time while on the jobsite, reducing labor costs on the project

#### Certified Silicone Free

- As always, all materials supplied by Hosco are "Certified Silicone and Contaminant Free" for installation into the Paint Circ System

## Union



Part Number	Description
4TF-4TF	1/4" TF x 1/4" TF
6TF-6TF	3/8" TF x 3/8" TF
8TF-8TF	1/2" TF x 1/2" TF
10TF-10TF	5/8" TF x 5/8" TF
12TF-12TF	3/4" TF x 3/4" TF
16TF-16TF	1" TF x 1" TF
20TF-20TF	1 1/4" TF x 1 1/4" TF
24TF-24TF	1 1/2" TF x 1 1/2" TF
32TF-32TF	2" TF x 2" TF

## Union 90° Elbow



Part Number	Description
4TF-4TF-90	1/4" TF x 1/4" TF 90
6TF-6TF-90	3/8" TF x 3/8" TF 90
8TF-8TF-90	1/2" TF x 1/2" TF 90
10TF-10TF-90	5/8" TF x 5/8" TF 90
12TF-12TF-90	3/4" TF x 3/4" TF 90
16TF-16TF-90	1" TF x 1" TF 90
20TF-20TF-90	1 1/4" TF x 1 1/4" TF 90
24TF-24TF-90	1 1/2" TF x 1 1/2" TF 90
32TF-32TF-90	2" TF x 2" TF 90

## Reducing Union



Part Number	Description
4TF-6TF	1/4" TF x 3/8" TF
4TF-8TF	1/4" TF x 1/2" TF
6TF-8TF	3/8" TF x 1/2" TF
6TF-10TF	3/8" TF x 5/8" TF
8TF-10TF	3/8" TF x 5/8" TF
6TF-12TF	3/8" TF x 3/4" TF
8TF-12TF	1/2" TF x 3/4" TF
10TF-12TF	5/8" TF x 3/4" TF
8TF-16TF	1/2" TF x 1" TF
12TF-16TF	3/4" TF x 1" TF



# Compression Fittings — Fractional Inch continued

## Female Connector

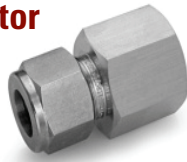

Part Number	Description
2T(F)-4TF	1/8" NPT(F) x 1/4" TF
4T(F)-4TF	1/4" NPT(F) x 1/4" TF
6T(F)-4TF	3/8" NPT(F) x 1/4" TF
8T(F)-4TF	1/2" NPT(F) x 1/4" TF
4T(F)-6TF	1/4" NPT(F) x 3/8" TF
6T(F)-6TF	3/8" NPT(F) x 3/8" TF
8T(F)-6TF	1/2" NPT(F) x 3/8" TF
4T(F)-8TF	1/4" NPT(F) x 1/2" TF
6T(F)-8TF	3/8" NPT(F) x 1/2" TF
8T(F)-8TF	1/2" NPT(F) x 1/2" TF
8T(F)-10TF	1/2" NPT(F) x 5/8" TF
8T(F)-12TF	1/2" NPT(F) x 3/4" TF
12T(F)-12TF	3/4" NPT(F) x 3/4" TF
16T(F)-16TF	1" NPT(F) x 1" TF
20T(F)-20TF	1 1/4" NPT(F) x 1 1/4" TF
24T(F)-24TF	1 1/2" NPT(F) x 1 1/2" TF

## Female 90° Elbow



Part Number	Description
2T(F)-4TF-90	1/8" NPT(F) x 1/4" TF 90
4T(F)-4TF-90	1/4" NPT(F) x 1/4" TF 90
4T(F)-6TF-90	1/4" NPT(F) x 3/8" TF 90
6T(F)-6TF-90	3/8" NPT(F) x 3/8" TF 90
8T(F)-6TF-90	1/2" NPT(F) x 3/8" TF 90
4T(F)-8TF-90	1/4" NPT(F) x 1/2" TF 90
6T(F)-8TF-90	3/8" NPT(F) x 1/2" TF 90
8T(F)-8TF-90	1/2" NPT(F) x 1/2" TF 90
8T(F)-10TF-90	1/2" NPT(F) x 5/8" TF 90
8T(F)-12TF-90	1/2" NPT(F) x 3/4" TF 90
12T(F)-12TF-90	3/4" NPT(F) x 3/4" TF 90
16T(F)-12TF-90	1" NPT(F) x 3/4" TF 90
16T(F)-16TF-90	1" NPT(F) x 1" TF 90

## Union Tee



Part Number	Description
4TF-4TF-4TF	1/4" TF x 1/4" TF x 1/4" TF
6TF-6TF-6TF	3/8" TF x 3/8" TF x 3/8" TF
8TF-8TF-8TF	1/2" TF x 1/2" TF x 1/2" TF
10TF-10TF-10TF	5/8" TF x 5/8" TF x 5/8" TF
12TF-12TF-12TF	3/4" TF x 3/4" TF x 3/4" TF
16TF-16TF-16TF	1" TF x 1" TF x 1" TF
20TF-20TF-20TF	1 1/4" TF x 1 1/4" TF x 1 1/4" TF
24TF-24TF-24TF	1 1/2" TF x 1 1/2" TF x 1 1/2" TF

## Female Branch Tee

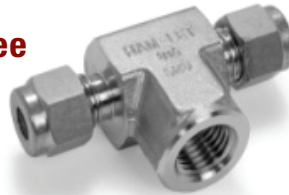

Part Number	Description
4TF-4TF-2T(F)	1/4" TF x 1/4" F x 1/8" NPT(F)
4TF-4TF-4T(F)	1/4" TF x 1/4" F x 1/4" NPT(F)
6TF-6TF-4T(F)	3/8" TF x 3/8" TF x 1/4" NPT(F)
6TF-6TF-6T(F)	3/8" TF x 3/8" TF x 3/8" NPT(F)
6TF-6TF-8T(F)	3/8" TF x 3/8" TF x 1/2" NPT(F)
8TF-8TF-4T(F)	1/2" TF x 1/2" TF x 1/4" NPT(F)
8TF-8TF-6T(F)	1/2" TF x 1/2" TF x 3/8" NPT(F)
8TF-8TF-8T(F)	1/2" TF x 1/2" TF x 3/8" NPT(F)
10TF-10TF-8T(F)	5/8" TF x 5/8" TF x 1/2" NPT(F)
12TF-12TF-12T(F)	3/4" TF x 3/4" TF x 3/4" NPT(F)
16TF-16TF-12T(F)	1" TF x 1" TF x 3/4" NPT(F)
16TF-16TF-16T(F)	1" TF x 1" TF x 1" NPT(F)

## Bulkhead Union



Part Number	Description
4TF-4BTF	1/4" TF x 1/4" BTF
6TF-6BTF	3/8" TF x 3/8" BTF
8TF-8BTF	1/2" TF x 1/2" BTF
10TF-10BTF	5/8" TF x 5/8" BTF
12TF-12BTF	3/4" TF x 3/4" BTF
16TF-16BTF	1" TF x 1" BTF
20TF-20BTF	1 1/4" TF x 1 1/4" BTF
24TF-24BTF	1 1/2" TF x 1 1/2" BTF

## Reducing Tees On Run and Branch

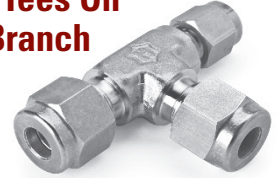

Part Number	Description
6TF-4TF-4TF	3/8" TF x 1/4" TF x 1/4" TF
8TF-4TF-4TF	1/2" TF x 1/4" TF x 1/4" TF
8TF-6TF-6TF	1/2" TF x 3/8" TF x 3/8" TF
10TF-6TF-6TF	5/8" TF x 3/8" TF x 3/8" TF
10TF-8TF-6TF	5/8" TF x 1/2" TF x 3/8" TF
10TF-8TF-8TF	5/8" TF x 1/2" TF x 1/2" TF
12TF-8TF-6TF	3/4" TF x 1/2" TF x 3/8" TF
12TF-8TF-8TF	3/4" TF x 1/2" TF x 1/2" TF
16TF-12TF-6TF	1" TF x 3/4" TF x 3/8" TF
16TF-12TF-8TF	1" TF x 3/4" TF x 1/2" TF
16TF-12TF-12TF	1" TF x 3/4" TF x 3/4" TF
20TF-16TF-16TF	1 1/4" TF x 1" TF x 1" TF
24TF-16TF-16TF	1 1/2" TF x 1" TF x 1" TF

## Reducing Tees On Branch



Part Number	Description
6TF-6TF-4TF	3/8" TF x 3/8" TF x 1/4" TF
8TF-8TF-4TF	1/2" TF x 1/2" TF x 1/4" TF
8TF-8TF-6TF	1/2" TF x 1/2" TF x 3/8" TF
10TF-10TF-6TF	5/8" TF x 5/8" TF x 3/8" TF
12TF-12TF-6TF	3/4" TF x 3/4" TF x 3/8" TF
12TF-12TF-8TF	3/4" TF x 3/4" TF x 1/2" TF
16TF-16TF-6TF	1" TF x 1" TF x 3/8" TF
16TF-16TF-8TF	1" TF x 1" TF x 1/2" TF
16TF-16TF-12TF	1" TF x 1" TF x 3/4" TF
20TF-20TF-16TF	1 1/4" TF x 1 1/4" TF x 1" TF
24TF-24TF-16TF	1 1/2" TF x 1 1/2" TF x 1" TF



# Compression Fittings — Fractional Inch continued

## Tube Cap



Part Number	Description
4TF-CAP	1/4" TF CLOSURE
6TF-CAP	3/8" TF CLOSURE
8TF-CAP	1/2" TF CLOSURE
10TF-CAP	5/8" TF CLOSURE
12TF-CAP	3/4" TF CLOSURE
16TF-CAP	1" TF CLOSURE
20TF-CAP	1 1/4" TF CLOSURE
24TF-CAP	1 1/2" TF CLOSURE

## Tube Plug



Part Number	Description
4TF-PLUG	1/4" TF NUT PLUG
6TF-PLUG	3/8" TF NUT PLUG
8TF-PLUG	1/2" TF NUT PLUG
10TF-PLUG	5/8" TF NUT PLUG
12TF-PLUG	3/4" TF NUT PLUG
16TF-PLUG	1" TF NUT PLUG
20TF-PLUG	1 1/4" TF NUT PLUG
24TF-PLUG	1 1/2" TF NUT PLUG
32TF-PLUG	2" TF NUT PLUG

## Reducer



Part Number	Description
4TF-6TUBE	1/4" TF X 3/8" OD TUBE STUB
4TF-8TUBE	1/4" TF X 1/2" OD TUBE STUB
4TF-10TUBE	1/4" TF X 5/8" OD TUBE STUB
4TF-12TUBE	1/4" TF X 3/4" OD TUBE STUB
6TF-4TUBE	3/8" TF X 1/4" OD TUBE STUB
6TF-8TUBE	3/8" TF X 1/2" OD TUBE STUB
6TF-10TUBE	3/8" TF X 5/8" OD TUBE STUB
6TF-12TUBE	3/8" TF X 3/4" OD TUBE STUB
8TF-4TUBE	1/2" TF X 1/4" OD TUBE STUB
8TF-6TUBE	1/2" TF X 3/8" OD TUBE STUB
8TF-12TUBE	1/2" TF X 3/4" OD TUBE STUB
8TF-16TUBE	1/2" TF X 1" OD TUBE STUB
10TF-12TUBE	5/8" TF X 3/4" OD TUBE STUB
10TF-16TUBE	5/8" TF X 1" OD TUBE STUB
12TF-8TUBE	3/4" TF X 1/2" OD TUBE STUB
12TF-16TUBE	3/4" TF X 1" OD TUBE STUB
16TF-20TUBE	1" TF X 1 1/4" OD TUBE STUB
16TF-24TUBE	1" TF X 1 1/2" OD TUBE STUB
20TF-24TUBE	1 1/4" TF X 1 1/2" OD TUBE STUB

## Male Tube Stub Adapter



Part No.	Description
4T-4TUBE	1/4" NPT(M) X 1/4" OD TUBE STUB
4T-6TUBE	1/4" NPT(M) X 3/8" OD TUBE STUB
4T-8TUBE	1/4" NPT(M) X 1/2" OD TUBE STUB
6T-6TUBE	3/8" NPT(M) X 3/8" OD TUBE STUB
6T-8TUBE	3/8" NPT(M) X 1/2" OD TUBE STUB
6T-12TUBE	3/8" NPT(M) X 3/4" OD TUBE STUB
8T-8TUBE	1/2" NPT(M) X 1/2" OD TUBE STUB
8T-12TUBE	1/2" NPT(M) X 3/4" OD TUBE STUB
12T-12TUBE	3/4" NPT(M) X 3/4" OD TUBE STUB
12T-16TUBE	3/4" NPT(M) X 1" OD TUBE STUB
16T-16TUBE	1" NPT(M) X 1" OD TUBE STUB
20T-20TUBE	1 1/4" NPT(M) X 1 1/4" OD TUBE STUB
24T-24TUBE	1 1/2" NPT(M) X 1 1/2" OD TUBE STUB

## Port Connector



Part Number	Description
4-PORT	1/4" TF PORT CONNECTOR
6-PORT	3/8" TF PORT CONNECTOR
8-PORT	1/2" TF PORT CONNECTOR
12-PORT	3/4" TF PORT CONNECTOR
16-PORT	1" TF PORT CONNECTOR
20-PORT	1 1/4" TF PORT CONNECTOR
24-PORT	1 1/2" TF PORT CONNECTOR
32-PORT	2" TF PORT CONNECTOR

## Female Tube Stub Adapter



Part No.	Description
4T(F)-4TUBE	1/4" NPT(F) x 1/4" OD TUBE STUB
4T(F)-6TUBE	1/4" NPT(F) x 3/8" OD TUBE STUB
4T(F)-8TUBE	1/4" NPT(F) x 1/2" OD TUBE STUB
6T(F)-4TUBE	3/8" NPT(F) x 1/4" OD TUBE STUB
6T(F)-6TUBE	3/8" NPT(F) x 3/8" OD TUBE STUB
6T(F)-8TUBE	3/8" NPT(F) x 1/2" OD TUBE STUB
8T(F)-8TUBE	1/2" NPT(F) x 1/2" OD TUBE STUB
8T(F)-10TUBE	1/2" NPT(F) x 5/8" OD TUBE STUB
8T(F)-12TUBE	1/2" NPT(F) x 3/4" OD TUBE STUB
12T(F)-12TUBE	3/4" NPT(F) x 3/4" OD TUBE STUB
12T(F)-16TUBE	3/4" NPT(F) x 1" OD TUBE STUB
16T(F)-16TUBE	1" NPT(F) x 1" OD TUBE STUB
20T(F)-20TUBE	1 1/4" NPT(F) x 1 1/4" OD TUBE STUB

## Nut



Part Number	Description
4-TFNSS	1/4" TUBE NUT
6-TFNSS	3/8" TUBE NUT
8-TFNSS	1/2" TUBE NUT
10-TFNSS	5/8" TUBE NUT
12-TFNSS	3/4" TUBE NUT
16-TFNSS	1" TUBE NUT
20-TFNSS	1 1/4" TUBE NUT
24-TFNSS	1 1/2" TUBE NUT
32-TFNSS	2" TUBE NUT

## Ferrule Set

(10 front/10 back)



Part Number	Description
4-DF-SS-SET	1/4" DUAL FERRULE SET/10
6-DF-SS-SET	3/8" DUAL FERRULE SET/10
8-DF-SS-SET	1/2" DUAL FERRULE SET/10
10-DF-SS-SET	5/8" DUAL FERRULE SET/10
12-DF-SS-SET	3/4" DUAL FERRULE SET/10
16-DF-SS-SET	1" DUAL FERRULE SET/10
20-DF-SS-SET	1 1/4" DUAL FERRULE SET/10
24-DF-SS-SET	1 1/2" DUAL FERRULE SET/10



# Compression Fittings — Metric

## Male Connector

BSPT To Metric  
Compression

Part Number	Description
2BT-6MMTF	1/8"BSPT(M) x 6MMTF
4BT-6MMTF	1/4"BSPT(M) X 6MMTF
6BT-6MMTF	3/8"BSPT(M) X 6MMTF
8BT-6MMTF	1/2"BSPT(M) X 6MMTF
2BT-8MMTF	1/8"BSPT(M) X 8MMTF
4BT-8MMTF	1/4"BSPT(M) X 8MMTF
6BT-8MMTF	3/8"BSPT(M) X 8MMTF
8BT-8MMTF	1/2"BSPT(M) X 8MMTF
4BT-10MMTF	1/4"BSPT(M) X 10MMTF
6BT-10MMTF	3/8"BSPT(M) X 10MMTF
8BT-10MMTF	1/2"BSPT(M) X 10MMTF
4BT-12MMTF	1/4"BSPT9M) X 12MMTF
6BT-12MMTF	3/8"BSPT(M) X 12MMTF
8BT-12MMTF	1/2"BSPT(M) X 12MMTF
12BT-18MMTF	3/4"BSPT(M) X 18MMTF
16BT-25MMTF	1"BSPT(M) X 25MMTF
24BT-38MMTF	1 1/2"BSPT(M) X 38MMTF

NPT To Metric  
Compression

Part Number	Description
2T-6MMTF	1/8"NPT(M) X 6MMTF
4T-6MMTF	1/4"NPT(M) X 6MMTF
6T-6MMTF	3/8"NPT(M) X 6MMTF
8T-6MMTF	1/2"NPT(M) X 6MMTF
2T-8MMTF	1/8"NPT(M) X 8MMTF
4T-8MMTF	1/4"NPT(M) X 8MMTF
6T-8MMTF	3/8"NPT(M) X 8MMTF
8T-8MMTF	1/2"NPT(M) X 8MMTF
4T-10MMTF	1/4"NPT(M) X 10MMTF
6T-10MMTF	3/8"NPT(M) X 10MMTF
8T-10MMTF	1/2"NPT(M) X 10MMTF
4T-12MMTF	1/4"NPT(M) X 12MMTF
6T-12MMTF	3/8"NPT(M) X 12MMTF
8T-12MMTF	1/2"NPT(M) X 12MMTF
12T-18MMTF	3/4"NPT(M) X 18MMTF
16T-25MMTF	1"NPT(M) X 25MMTF
24T-38MMTF	1 1/2"NPT(M) X 38MMTF



Hosco provides the highest quality 316 Stainless Steel Compression & Instrumentation Fittings for installation into paint and coating applications. These compression tube fittings have heat code traceability and our quality raw materials come from US, France, and Italy. Third party testing from TUV proves our intermixability with the other industry leaders. Hosco can offer technical assistance and training on these fittings which are fully gaugeable with the same installation and remake instructions as the other top tier suppliers of these two ferrule compression fittings.

## Feature and Benefits

### Wide Array of Sizes/Configurations

- Availability of all known Paint Circulation design connections for SST Paint Circ Systems

### Local Inventory Commitment

- Able to supply from inventory and maintain a safety stock of unusual sizes used in Paint Circ System designs

### Custom Assemblies with Hosco's Core Product Lines

- Hosco can "kit up" compression fittings, ball valves, hoses and fittings needed to reduce prep time while on the jobsite, reducing labor costs on the project

### Certified Silicone Free

- As always, all materials supplied by Hosco are "Certified Silicone and Contaminant Free" for installation into the Paint Circ System

Many additional sizes available; call Hosco for more information.

## Male 90° Elbow Connector

BSPT To Metric  
Compression

Part Number	Description
2BT-6MMTF-90	1/8" BSPT(M) x 6MMTF-90
4BT-6MMTF-90	1/4" BSPT(M) X 6MMTF-90
6BT-6MMTF-90	3/8" BSPT(M) X 6MMTF-90
8BT-6MMTF-90	1/2" BSPT(M) X 6MMTF-90
2BT-8MMTF-90	1/8" BSPT(M) X 8MMTF-90
4BT-8MMTF-90	1/4" BSPT(M) X 8MMTF-90
6BT-8MMTF-90	3/8" BSPT(M) X 8MMTF-90
8BT-8MMTF-90	1/2" BSPT(M) X 8MMTF-90
4BT-10MMTF-90	1/4" BSPT(M) X 10MMTF-90
6BT-10MMTF-90	3/8" BSPT(M) X 10MMTF-90
8BT-10MMTF-90	1/2" BSPT(M) X 10MMTF-90
4BT-12MMTF-90	1/4" BSPT(M) X 12MMTF-90
6BT-12MMTF-90	3/8" BSPT(M) X 12MMTF-90
8BT-12MMTF-90	1/2" BSPT(M) X 12MMTF-90
12BT-18MMTF-90	3/4" BSPT(M) X 18MMTF-90
16BT-25MMTF-90	1" BSPT(M) X 25MMTF-90

NPT To Metric  
Compression

Part Number	Description
2T-6MMTF-90	1/8"NPT(M) X 6MMTF-90
4T-6MMTF-90	1/4"NPT(M) X 6MMTF-90
6T-6MMTF-90	3/8"NPT(M) X 6MMTF-90
8T-6MMTF-90	1/2"NPT(M) X 6MMTF-90
2T-8MMTF-90	1/8"NPT(M) X 8MMTF-90
4T-8MMTF-90	1/4"NPT(M) X 8MMTF-90
6T-8MMTF-90	3/8"NPT(M) X 8MMTF-90
8T-8MMTF-90	1/2"NPT(M) X 8MMTF-90
4T-10MMTF-90	1/4"NPT(M) X 10MMTF-90
6T-10MMTF-90	3/8"NPT(M) X 10MMTF-90
8T-10MMTF-90	1/2"NPT(M) X 10MMTF-90
4T-12MMTF-90	1/4"NPT(M) X 12MMTF-90
6T-12MMTF-90	3/8"NPT(M) X 12MMTF-90
8T-12MMTF-90	1/2"NPT(M) X 12MMTF-90
12T-18MMTF-90	3/4"NPT(M) X 18MMTF-90
16T-25MMTF-90	1"NPT(M) X 25MMTF-90
24T-38MMTF-90	1 1/2"NPT(M) X 38MMTF-90







# Compression Fittings — Metric continued

## Union

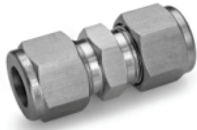

Part Number	Description
6MMTF-6MMTF	6MMTF X 6MMTF
8MMTF-8MMTF	8MMTF X 8MMTF
10MMTF-10MMTF	10MMTF X 10MMTF
12MMTF-12MMTF	12MMTF X 12MMTF
14MMTF-14MMTF	14MMTF X 14MMTF
16MMTF-16MMTF	16MMTF X 16MMTF
18MMTF-18MMTF	18MMTF X 18MMTF
20MMTF-20MMTF	20MMTF X 20MMTF
22MMTF-22MMTF	22MMTF X 22MMTF
25MMTF-25MMTF	25MMTF X 25MMTF
38MMTF-38MMTF	38MMTF X 38MMTF
50MMTF-50MMTF	50MMTF X 50MMTF

## Union 90° Elbow



Part Number	Description
6MMTF-6MMTF-90	6MMTF X 6MMTF 90
8MMTF-8MMTF-90	8MMTF X 8MMTF 90
10MMTF-10MMTF-90	10MMTF X 10MMTF 90
12MMTF-12MMTF-90	12MMTF X 12MMTF 90
14MMTF-14MMTF-90	14MMTF X 14MMTF 90
16MMTF-16MMTF-90	16MMTF X 16MMTF 90
18MMTF-18MMTF-90	18MMTF X 18MMTF 90
20MMTF-20MMTF-90	20MMTF X 20MMTF 90
22MMTF-22MMTF-90	22MMTF X 22MMTF 90
25MMTF-25MMTF-90	25MMTF X 25MMTF 90
38MMTF-38MMTF-90	38MMTF X 38MMTF 90
50MMTF-50MMTF-90	50MMTF X 50MMTF 90

## Reducing Union



Part Number	Description
6MMTF-8MMTF	6MMTF x 8MMTF
6MMTF-10MMTF	6MMTF x 10MMTF
6MMTF-12MMTF	6MMTF x 12MMTF
8MMTF-10MMTF	8MMTF x 10MMTF
8MMTF-12MMTF	8MMTF x 12MMTF
10MMTF-12MMTF	10MMTF x 12MMTF
10MMTF-16MMTF	10MMTF x 16MMTF
12MMTF-16MMTF	12MMTF x 16MMTF
12MMTF-18MMTF	12MMTF x 18MMTF
18MMTF-25MMTF	18MMTF x 25MMTF
20MMTF-25MMTF	20MMTF x 25MMTF
20MMTF-38MMTF	20MMTF x 38MMTF
25MMTF-38MMTF	24MMTF x 38MMTF

## Bulkhead Union

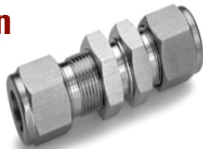

Part Number	Description
6MMTF-6MMBTF	6MMTF X 6MMBTF
8MMTF-8MMBTF	8MMTF X 8MMBTF
10MMTF-10MMBTF	10MMTF X 10MMBTF
12MMTF-12MMBTF	12MMTF X 12MMBTF
14MMTF-14MMBTF	14MMTF X 14MMBTF
16MMTF-16MMBTF	16MMTF X 16MMBTF
18MMTF-18MMBTF	18MMTF X 18MMBTF
20MMTF-20MMBTF	20MMTF X 20MMBTF
25MMTF-25MMBTF	25MMTF X 25MMBTF
38MMTF-38MMBTF	35MMTF X 38MMBTF

## Female Connector

BSPT To Metric  
Compression

Part Number	Description
2BT(F)-6MMTF	1/8" BSPT(F) X 6MMTF
4BT(F)-6MMTF	1/4" BSPT(F) X 6MMTF
6BT(F)-6MMTF	3/8" BSPT(F) X 6MMTF
8BT(F)-6MMTF	1/2" BSPT(F) X 6MMTF
2BT(F)-8MMTF	1/8" BSPT(F) X 8MMTF
4BT(F)-8MMTF	1/4" BSPT(F) X 6MMTF
6BT(F)-8MMTF	3/8" BSPT(F) X 8MMTF
8BT(F)-8MMTF	1/2" BSPT(F) X 8MMTF
4BT(F)-10MMTF	1/4" BSPT(F) X 10MMTF
6BT(F)-10MMTF	3/8" BSPT(F) X 10MMTF
8BT(F)-10MMTF	1/2" BSPT(F) X 10MMTF
4BT(F)-12MMTF	1/4" BSPT(F) X 12MMTF
6BT(F)-12MMTF	3/8" BSPT(F) X 12MMTF
8BT(F)-12MMTF	1/2" BSPT(F) X 12MMTF
12BT(F)-12MMTF	3/4" BSPT(F) X 18MMTF
16BT(F)-25MMTF	1" BSPT(F) X 25MMTF

NPT To Metric  
Compression



Part Number	Description
2T(F)-6MMTF	1/8" NPT(F) X 6MMTF
4T(F)-6MMTF	1/4" NPT(F) X 6MMTF
6T(F)-6MMTF	3/8" NPT(F) X 6MMTF
8T(F)-6MMTF	1/2" NPT(F) X 6MMTF
2T(F)-8MMTF	1/8" NPT(F) X 8MMTF
4T(F)-8MMTF	1/4" NPT(F) X 6MMTF
6T(F)-8MMTF	3/8" NPT(F) X 8MMTF
8T(F)-8MMTF	1/2" NPT(F) X 8MMTF
4T(F)-10MMTF	1/4" NPT(F) X 10MMTF
6T(F)-10MMTF	3/8" NPT(F) X 10MMTF
8T(F)-10MMTF	1/2" NPT(F) X 10MMTF
4T(F)-12MMTF	1/4" NPT(F) X 12MMTF
6T(F)-12MMTF	3/8" NPT(F) X 12MMTF
8T(F)-12MMTF	1/2" NPT(F) X 12MMTF
12T(F)-12MMTF	3/4" NPT(F) X 18MMTF
16T(F)-25MMTF	1" NPT(F) X 25MMTF

Many additional sizes available; call Hosco for more information.



# Compression Fittings — Metric continued

## Union Tee



Part Number	Description
8MMTF-8MMTF-8MMTF	8MMTF x 8MMTF x 8MMTF
10MMTF-10MMTF-10MMTF	10MMTF x 10MMTF x 10MMTF
12MMTF-12MMTF-12MMTF	12MMTF x 12MMTF x 12MMTF
14MMTF-14MMTF-14MMTF	14MMTF x 14MMTF x 14MMTF
16MMTF-16MMTF-16MMTF	16MMTF x 16MMTF x 16MMTF
18MMTF-18MMTF-18MMTF	18MMTF x 18MMTF x 18MMTF
20MMTF-20MMTF-20MMTF	20MMTF x 20MMTF x 20MMTF
22MMTF-22MMTF-22MMTF	22MMTF x 22MMTF x 22MMTF
25MMTF-25MMTF-25MMTF	25MMTF x 25MMTF x 25MMTF
38MMTF-38MMTF-38MMTF	38MMTF x 38MMTF x 38MMTF
50MMTF-50MMTF-50MMTF	50MMTF x 50MMTF x 50MMTF

## Reducing Tees On Branch

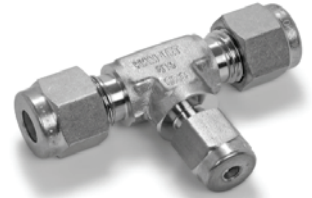

Part Number	Description
8MMTF-8MMTF-6MMTF	8MMTF X 8MMTF X 6MMTF
10MMTF-10MMTF-6MMTF	10MMTF X 10MMTF X 6MMTF
12MMTF-12MMTF-6MMTF	12MMTF X 12MMTF X 6MMTF
12MMTF-12MMTF-10MMTF	12MMTF X 12MMTF X 10MMTF
14MMTF-14MMTF-10MMTF	14MMTF X 14MMTF X 10MMTF
18MMTF-18MMTF-12MMTF	18MMTF X 18MMTF X 12MMTF
50MMTF-50MMTF-38MMTF	50MMTF X 50MMTF X 38MMTF

## Female Branch Tee

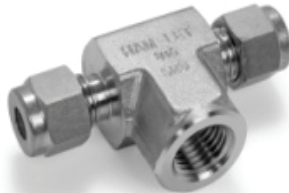

Part Number	Description
6MMTF-6MMTF-2T(F)	6MMTF x 6MMTF X 1/8" NPT F
6MMTF-6MMTF-4T(F)	6MMTF x 6MMTF X 1/4" NPT F
8MMTF-8MMTF-2T(F)	8MMTF x 8MMTF X 1/8" NPT F
8MMTF-8MMTF-4T(F)	8MMTF x 8MMTF X 1/4" NPT F
10MMTF-10MMTF-4T(F)	10MMTF x 10MMTF X 1/4" NPT F
10MMTF-10MMTF-6T(F)	10MMTF x 10MMTF X 3/8" NPT F
12MMTF-12MMTF-4T(F)	12MMTF x 12MMTF X 1/4" NPT F
12MMTF-12MMTF-6T(F)	12MMTF x 12MMTF X 3/8" NPT F
12MMTF-12MMTF-8T(F)	12MMTF x 12MMTF X 1/2" NPT F
16MMTF-16MMTF-8T(F)	16MMTF x 16MMTF X 1/2" NPT F

## Tube Cap



Part Number	Description
8MMTF-CAP	8MMTF CLOSURE
10MMTF-CAP	10MMTF CLOSURE
12MMTF-CAP	12MMTF CLOSURE
14MMTF-CAP	14MMTF CLOSURE
16MMTF-CAP	16MMTF CLOSURE
18MMTF-CAP	18MMTF CLOSURE
20MMTF-CAP	20MMTF CLOSURE
22MMTF-CAP	22MMTF CLOSURE
25MMTF-CAP	25MMTF CLOSURE
38MMTF-CAP	38MMTF CLOSURE

## Female 90° Elbow



NPT To Metric Compression

Part Number	Description
2T(F)-6MMTF-90	1/8" NPT(F) x 6MMTF 90
4T(F)-6MMTF-90	1/4" NPT(F) x 6MMTF 90
4T(F)-8MMTF-90	1/4" NPT(F) x 8MMTF 90
4T(F)-10MMTF-90	1/4" NPT(F) x 10MMTF 90
4T(F)-12MMTF-90	1/4" NPT(F) x 12MMTF 90
8T(F)-12MMTF-90	1/2" NPT(F) x 12MMTF 90
8T(F)-16MMTF-90	1/2" NPT(F) x 12MMTF 90

## Tube Plug



Part Number	Description
8MM-PLUG	8MMTF NUT PLUG
10MM-PLUG	10MMTF NUT PLUG
12MM-PLUG	12MMTF NUT PLUG
14MM-PLUG	14MMTF NUT PLUG
16MM-PLUG	16MMTF NUT PLUG
18MM-PLUG	18MMTF NUT PLUG
20MM-PLUG	20MMTF NUT PLUG
22MM-PLUG	22MMTF NUT PLUG
25MM-PLUG	25MMTF NUT PLUG
38MM-PLUG	38MMTF NUT PLUG
50MM-PLUG	50MMTF NUT PLUG

Many additional sizes available; call Hosco for more information.



# Compression Fittings — Metric continued

## Male Tube Stub Adapter



Part No.	Description
2BT-6MMTUBE	1/8"BSPT(M) X 6MMTUBE
4BT-6MMTUBE	1/4"BSPT(M) X 6MMTUBE
2BT-8MMTUBE	1/8"BSPT(M) X 8MMTUBE
4BT-8MMTUBE	1/4"BSPT(M) X 8MMTUBE
6BT-8MMTUBE	3/8"BSPT(M) X 8MMTUBE
8BT-8MMTUBE	1/2"BSPT(M) X 8MMTUBE
4BT-10MMTUBE	1/4"BSPT(M) X 10MMTUBE
6BT-10MMTUBE	3/8"BSPT(M) X 10MMTUBE
8BT-10MMTUBE	1/2"BSPT(M) X 10MMTUBE
4BT-12MMTUBE	1/4"BSPT(M) X 12MMTUBE
6BT-12MMTUBE	3/8"BSPT(M) X 12MMTUBE
8BT-12MMTUBE	1/2"BSPT(M) X 12MMTUBE
12BT-20MMTUBE	3/4"BSPT(M) X 20MMTUBE

## Reducer



Part Number	Description
6MMTF-8MMTUBE	6MMTF X 8MM TUBE STUB
6MMTF-10MMTUBE	6MMTF X 10MM TUBE STUB
8MMTF-6MMTUBE	8MMTF X 6MM TUBE STUB
8MMTF-10MMTUBE	8MMTF X 10MM TUBE STUB
8MMTF-12MMTUBE	8MMTF X 12MM TUBE STUB
10MMTF-6MMTUBE	10MMTF X 6MM TUBE STUB
10MMTF-8MMTUBE	10MMTF X 8MM TUBE STUB
10MMTF-12MMTUBE	10MMTF X 12MM TUBE STUB
12MMTF-6MMTUBE	12MMTF X 6MM TUBE STUB
12MMTF-8MMTUBE	12MMTF X 8MM TUBE STUB
12MMTF-10MMTUBE	12MMTF X 10MM TUBE STUB
12MMTF-16MMTUBE	12MMTF X 16MM TUBE STUB
16MMTF-12MMTUBE	16MMTF X 12MM TUBE STUB
18MMTF-16MMTUBE	18MMTF X 16MM TUBE STUB
18MMTF-20MMTUBE	18MMTF X 20MM TUBE STUB
18MMTF-22MMTUBE	18MMTF X 22MM TUBE STUB
18MMTF-25MMTUBE	18MMTF X 25MM TUBE STUB
25MMTF-18MMTUBE	25MMTF X 18MM TUBE STUB
25MMTF-20MMTUBE	25MMTF X 20MM TUBE STUB

## Nut



Part Number	Description
6MM-TFNSS	6MM TUBE NUT
8MM-TFNSS	8MM TUBE NUT
10MM-TFNSS	10MM TUBE NUT
12MM-TFNSS	12MM TUBE NUT
14MM-TFNSS	14MM TUBE NUT
16MM-TFNSS	16MM TUBE NUT
18MM-TFNSS	18MM TUBE NUT
20MM-TFNSS	20MM TUBE NUT
22MM-TFNSS	22MM TUBE NUT
25MM-TFNSS	25MM TUBE NUT
38MM-TFNSS	38MM TUBE NUT
50MM-TFNSS	50MM TUBE NUT

## Ferrule Set

(10 front/10 back)



Part Number	Description
6MM-DF-SS-SET	6MM DUAL FERRULE SET/10
8MM-DF-SS-SET	8MM DUAL FERRULE SET/10
10MM-DF-SS-SET	10MM DUAL FERRULE SET/10
12MM-DF-SS-SET	12MM DUAL FERRULE SET/10
14MM-DF-SS-SET	14MM DUAL FERRULE SET/10
16MM-DF-SS-SET	16MM DUAL FERRULE SET/10
18MM-DF-SS-SET	18MM DUAL FERRULE SET/10
20MM-DF-SS-SET	20MM DUAL FERRULE SET/10
22MM-DF-SS-SET	22MM DUAL FERRULE SET/10
25MM-DF-SS-SET	25MM DUAL FERRULE SET/10
38MM-DF-SS-SET	38MM DUAL FERRULE SET/10
50MM-DF-SS-SET	50MM DUAL FERRULE SET/10

## Port Connector



Part Number	Description
6MM-PORT	6MMTF PORT CONNECTOR
8MM-PORT	8MMTF PORT CONNECTOR
10MM-PORT	10MMTF PORT CONNECTOR
12MM-PORT	12MMTF PORT CONNECTOR
14MM-PORT	14MMTF PORT CONNECTOR
16MM-PORT	16MMTF PORT CONNECTOR
18MM-PORT	18MMTF PORT CONNECTOR
25MM-PORT	25MMTF PORT CONNECTOR
38MM-PORT	38MMTF PORT CONNECTOR

Many additional sizes available; call Hosco for more information.

Installing new or modifying existing piping systems for process fluids such as paint or high viscosity sealer header systems has never been faster or easier than with the Hosco PreFiS connector family of products.

Available in 316 SST wetted parts for paint or process fluids and carbon steel for high pressure systems, the PreFiS system of connectors is a full line of couplings, reducing couplings, tees, reducing tees, lateral wyes, and others to provide smooth-bore, cavity and silicone-free, and low shear operation—the attributes which serve as Hosco's cornerstone of design.

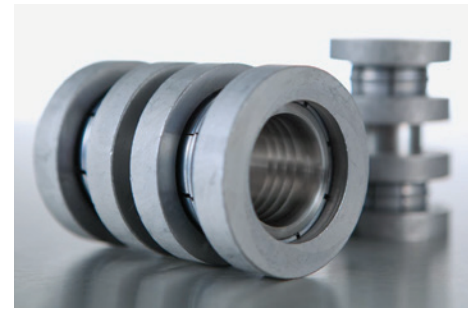

## Tooling

The installation of the press fitting is done with the help of a press tool and a high pressure pump. Our press tools come in an open or closed configuration, are easy to handle, and can be used in narrow spaces satisfying the tight center-to-center requirements.

## Components

PreFiS products consist of a cylindrical body with a clogged inner surface and two press ring sets. It only takes a few seconds to crimp the fitting onto the pipe.

No PST sealant, gaskets, o-rings, or welding required for a clean and secure installation of the PreFiS connectors.

- Press rings
- Coupling Sleeve
- Slide Rings
- Pipe

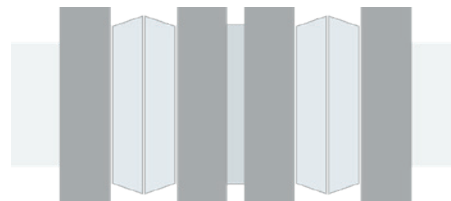

Unpressed Condition

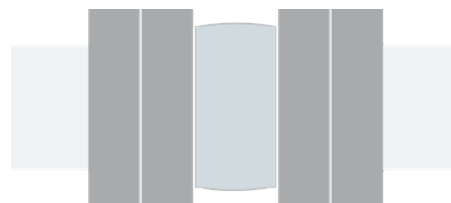

Pressed Condition

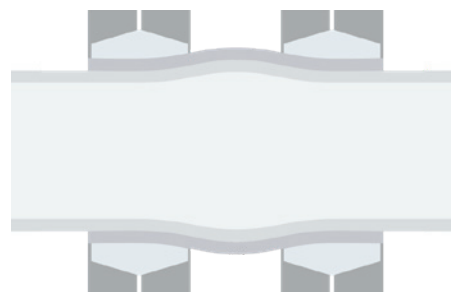

Pressed Condition (cross section)

## Advantages

- Reduced Installation time: Complete a 2" carbon steel fitting in 40 seconds per side; 3" in 90 seconds per side
- Less effort: No PST sealant, gaskets, o-rings or welding required
- Resistance to high pressures, temperatures and chemicals
- Available in various configurations and dimensions

## Pipe/Tube Diameter

### Carbon steel

3/8" – 3.5" (10.0 – 88.9 mm)

### Stainless steel

3/8" – 3.0" (10.0 – 76.1 mm)

## Temperature Range

-67°F – 572°F (-55°C – 400°C)

## Pressures

### Carbon steel

up to 9137 psi (630 bar) operating pressure

### Stainless steel

up to 3770 psi (260 bar) operating pressure

## Approvals





# PreFiS™ Stainless Steel Connectors For Tube

## Straight Union

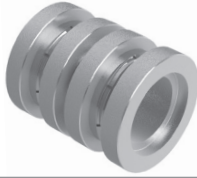

Part Number	Description
HPTF-0606-SS	UNION - SS - 3/8 X 3/8
HPTF-0808-SS	UNION - SS - 1/2 X 1/2
HPTF-1212-SS	UNION - SS - 3/4 X 3/4
HPTF-1616-SS	UNION - SS - 1 X 1
HPTF-2020-SS	UNION - SS - 1 1/4 X 1 1/4
HPTF-2424-SS	UNION - SS - 1 1/2 X 1 1/2
HPTF-3232-SS	UNION - SS - 2 X 2
HPTF-4040-SS	UNION - SS - 2 1/2 X 2 1/2
HPTF-4848-SS	UNION - SS - 3 X 3
HPTF-5656-SS	UNION - SS - 3 1/2 X 3 1/2

## Reducing Union

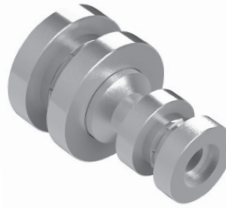

Part Number	Description
HPTF-1612-SS	REDUCER - SS - 1 X 3/4
HPTF-2016-SS	REDUCER - SS - 1 1/4 X 1
HPTF-2420-SS	REDUCER - SS - 1 1/2 X 1 1/4
HPTF-3224-SS	REDUCER - SS - 2 X 1 1/2
HPTF-4032-SS	REDUCER - SS - 2 1/2 X 2

## Open Tool

For use with tubing.

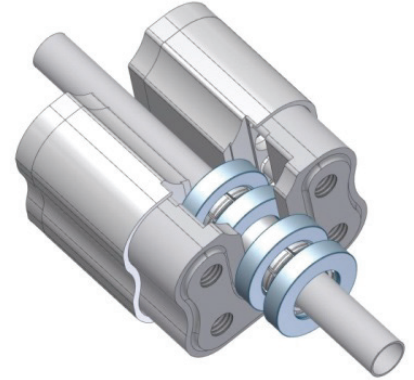

## 90° Elbow



Part Number	Description
HPTF-EL-0606-SS	ELBOW - SS - 3/8 X 3/8
HPTF-EL-0808-SS	ELBOW - SS - 1/2 X 1/2
HPTF-EL-1212-SS	ELBOW - SS - 3/4 X 3/4
HPTF-EL-1616-SS	ELBOW - SS - 1 X 1
HPTF-EL-2020-SS	ELBOW - SS - 1 1/4 X 1 1/4
HPTF-EL-2424-SS	ELBOW - SS - 1 1/2 X 1 1/2
HPTF-EL-3232-SS	ELBOW - SS - 2 X 2
HPTF-EL-4040-SS	ELBOW - SS - 2 1/2 X 2 1/2
HPTF-EL-4848-SS	ELBOW - SS - 3 X 3
HPTF-EL-5656-SS	ELBOW - SS - 3 1/2 X 3 1/2

## Union Tees



Part Number	Description
HPTF-3232-32-SS	TEE - SS - 2 X 2 X 2
HPTF-2424-24-SS	TEE - SS - 1 1/2 X 1 1/2 X 1 1/2
HPTF-2020-20-SS	TEE - SS - 1 1/4 X 1 1/4 X 1 1/4
HPTF-1616-16-SS	TEE - SS - 1 X 1 X 1
HPTF-1212-12-SS	TEE - SS - 3/4 X 3/4 X 3/4
HPTF-0808-08-SS	TEE - SS - 1/2 X 1/2 X 1/2

## Power Unit

For use with open tool.



## Reducing Tees On Run and Branch



Part Number	Description
HPTF-2420-06-SS	RTEE - SS - 2420 - 06
HPTF-2420-08-SS	RTEE - SS - 2420 - 08
HPTF-2420-10-SS	RTEE - SS - 2420 - 10
HPTF-2016-06-SS	RTEE - SS - 2016 - 06
HPTF-2016-08-SS	RTEE - SS - 2016 - 08
HPTF-2016-10-SS	RTEE - SS - 2016 - 10
HPTF-1612-06-SS	RTEE - SS - 1612 - 06
HPTF-1612-08-SS	RTEE - SS - 1612 - 08
HPTF-1612-10-SS	RTEE - SS - 1612 - 10

## Reducing Tees On Branch



Part Number	Description
HPTF-2424-06-SS	RTEE - SS - 2424 - 06
HPTF-2424-08-SS	RTEE - SS - 2424 - 08
HPTF-2424-10-SS	RTEE - SS - 2424 - 10
HPTF-2020-06-SS	RTEE - SS - 2020 - 06
HPTF-2020-08-SS	RTEE - SS - 2020 - 08
HPTF-2020-10-SS	RTEE - SS - 2020 - 10
HPTF-1616-06-SS	RTEE - SS - 1616 - 06
HPTF-1616-08-SS	RTEE - SS - 1616 - 08
HPTF-1616-10-SS	RTEE - SS - 1616 - 10
HPTF-1212-06-SS	RTEE - SS - 1212 - 06
HPTF-1212-08-SS	RTEE - SS - 1212 - 08
HPTF-1212-10-SS	RTEE - SS - 1212 - 10



# PreFiS™ Connectors For Pipe

**NOTE:** •• Indicates material. When ordering, please specify SS for Stainless and CS for Carbon.

## Straight Union



Part Number	Description
HPPF-0606-••	UNION - •• - 3/8 X 3/8
HPPF-0808-••	UNION - •• - 1/2 X 1/2
HPPF-1212-••	UNION - •• - 3/4 X 3/4
HPPF-1616-••	UNION - •• - 1 X 1
HPPF-2020-••	UNION - •• - 1 1/4 X 1 1/4
HPPF-2424-••	UNION - •• - 1 1/2 X 1 1/2
HPPF-3232-••	UNION - •• - 2 X 2
HPPF-4040-••	UNION - •• - 2 1/2 X 2 1/2
HPPF-4848-••	UNION - •• - 3 X 3

## Reducing Union

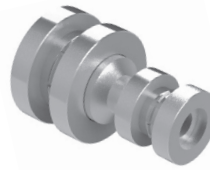

Part Number	Description
HPPF-1612-••	REDUCER - •• - 1 X 3/4
HPPF-2016-••	REDUCER - •• - 1 1/4 X 1
HPPF-2420-••	REDUCER - •• - 1 1/2 X 1 1/4
HPPF-3224-••	REDUCER - •• - 2 X 1 1/2
HPPF-4032-••	REDUCER - •• - 2 1/2 X 2
HPPF-4832-••	REDUCER - •• - 3 X 2

## Closed Tool

For use with pipe.

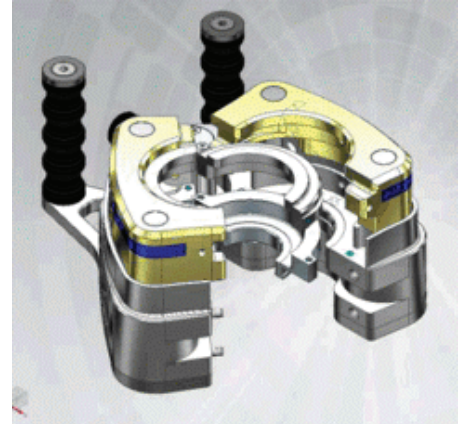

## Union Tees



Part Number	Description
HPPF-4848-48-••	TEE - •• - 3 X 3 X 3
HPPF-3232-32-••	TEE - •• - 2 X 2 X 2
HPPF-2424-24-••	TEE - •• - 1 1/2 X 1 1/2 X 1 1/2
HPPF-2020-20-••	TEE - •• - 1 1/4 X 1 1/4 X 1 1/4
HPPF-1616-16-••	TEE - •• - 1 X 1 X 1
HPPF-1212-12-••	TEE - •• - 3/4 X 3/4 X 3/4
HPPF-0808-08-••	TEE - •• - 1/2 X 1/2 X 1/2

## Reducing Tees On Branch



Part Number	Description
HPPF-2424-06-••	RTEE - •• - 2424 - 06
HPPF-2424-08-••	RTEE - •• - 2424 - 08
HPPF-2424-10-••	RTEE - •• - 2424 - 10
HPPF-2020-06-••	RTEE - •• - 2020 - 06
HPPF-2020-08-••	RTEE - •• - 2020 - 08
HPPF-2020-10-••	RTEE - •• - 2020 - 10
HPPF-1616-06-••	RTEE - •• - 1616 - 06
HPPF-1616-08-••	RTEE - •• - 1616 - 08
HPPF-1616-10-••	RTEE - •• - 1616 - 10
HPPF-1212-06-••	RTEE - •• - 1212 - 06
HPPF-1212-08-••	RTEE - •• - 1212 - 08
HPPF-1212-10-••	RTEE - •• - 1212 - 10

## Power Unit

Can be used with open or closed tool.



## 90° Elbow



Part Number	Description
HPPF-EL-0606-••	ELBOW - •• - 3/8 X 3/8
HPPF-EL-0808-••	ELBOW - •• - 1/2 X 1/2
HPPF-EL-1212-••	ELBOW - •• - 3/4 X 3/4
HPPF-EL-1616-••	ELBOW - •• - 1 X 1
HPPF-EL-2020-••	ELBOW - •• - 1 1/4 X 1 1/4
HPPF-EL-2424-••	ELBOW - •• - 1 1/2 X 1 1/2
HPPF-EL-3232-••	ELBOW - •• - 2 X 2
HPPF-EL-4040-••	ELBOW - •• - 2 1/2 X 2 1/2
HPPF-EL-4848-••	ELBOW - •• - 3 X 3

## Reducing Tees On Run and Branch



Part Number	Description
HPPF-2420-06-••	RTEE - •• - 2420 - 06
HPPF-2420-08-••	RTEE - •• - 2420 - 08
HPPF-2420-10-••	RTEE - •• - 2420 - 10
HPPF-2016-06-••	RTEE - •• - 2016 - 06
HPPF-2016-08-••	RTEE - •• - 2016 - 08
HPPF-2016-10-••	RTEE - •• - 2016 - 10
HPPF-1612-06-••	RTEE - •• - 1612 - 06
HPPF-1612-08-••	RTEE - •• - 1612 - 08
HPPF-1612-10-••	RTEE - •• - 1612 - 10

# Bundled Tubing Systems

**SILICONE  
CERTIFIED  
FREE**



8M ID Piggable Hose Bundle with Ancillary Support Hose and Tubes



Rotary Atomizer Control Bundle with Unique Hose and Tube Markings



Robotic Paint and Air Supply Bundle



Pneumatic/Air Pilot Bundle-24 Lines

Hosco has pioneered the Bundled Tubing applications for paint shops and paint operations. The use of bundled tubing significantly increases hose and tubing life versus loose lines in cattracks or cable trays where motion is present- as much as 8-10 times longer life. In addition, incorporating the proprietary jacket cover that resists chaffing, cracking and all know solvents and paints provides a scuff guard and provides containment should there be a hose or tubing release or failure in the bundle for any reason. Hosco can specifically engineer a bundle up to a jacket diameter of approximately 1 1/2" and have supplied up to 18 interior lines (24 for air pilots) of various colors, resin types (FEP, PTFE, or Nylon-PA) in up to 530 feet continuous coils or cut lengths as specified. Custom laylines identifying each interior line can be done, as well as private label marking of the interior lines or outside jacket for a relatively small cost increase.

## Robot/Automation Bundles

Part No.	Description
HOA-40405	Hose Bundle: (4) NP-5 Natural lines marked S1, S2, R1, R2 for Paint lines
HOA-41947	Hose Bundle: (5) NHA-0302 <b>R B N G BL</b> (2) NHA-375275 <b>B N</b> Custom Printed
HOA-42283	Hose Bundle: (1) NHA-0504, (5) NHA-0403, (3) NHA-0806 Custom Printed, 265 ft. reel
HOA-42284	Hose Bundle: (5) NHA-532332, (1) NHA-375275 Custom Printed and/or Colors
HOA-42285	Hose Bundle: (2) NHA-532332, (1) NHA-0403, (1) NHA-375275 Custom Printed
HOA-42346	Hose Bundle: (3) NHA-0302 <b>BL G B</b> , (2) NHA-0504 <b>BL G</b> , (2) NHA-375275 <b>B N</b> Custom Printed
HOA-42347	Hose Bundle: (7) NHA-0302 <b>Y W R G B N BL</b> , (4) NHA-375275 <b>2 R 2 N</b> , (1) NHA-0504- <b>BL</b> , (2) NHA-0403 <b>B N</b> Custom Printed
HOA-42348	Hose Bundle: (2) NHA-0504 <b>G W</b> , (2) PTFM-8x6, (5) NHA-0302 <b>OR B W R BL</b> , (2) FEP-0302, (2) NHA-375275 <b>B R</b> , (3) NHA-0403 <b>R W B</b> Custom Printed
HOA-43257	Hose Bundle: (2) NHA-375275, (1) NHA-532332 Custom Printed
HOA-44725	Hose Bundle: (1) NHA-532332, (1) NHA-375275, (2) NHA-10X7 <b>B R</b> , (2) FEP-0503 Custom Printed and Colors
HOA-44726	Hose Bundle: (4) NHA-532332, (4) NHA-6x4, (5) NHA-8x6, (2) FEPM-8x6 Custom Printed and Colors
HOA-45065	Hose Bundle: (4) NHA-375275, (2) NHA-532332 Custom Printed
HOA-45389	Hose Bundle: (7) NHA-0403 <b>R G B Y N BL</b> , (2) NHA-0806 <b>R BL</b> , (2) NHA-375275 <b>G B</b> , (1) NHA-0504Y <b>Y</b> Custom Printed
HOA-45451	Hose Bundle: (6) NHA-8x6, (4) NHA-6x4, (8) NHA-4x2.7 Custom Printed
HOA-45613B	Hose Bundle: (5) NHA-4x2.7, (2) NHA-8x6, (3) NHA-375275 <b>S G B</b> Custom Printed
HOA-45614A	Hose Bundle: (4) FEP-0503, (1) FEP-0806

## Feature and Benefits

### Custom Engineering Capabilities

- Hosco can provide an unlimited combination of hose and tubing sizes, colors, hose markings and resins to provide quick identification of lines in the bundle for maintenance actions in up to 530 feet long coils

### Great Value for Operations

- With up to 8-10 times longer life and enhances safety of nesting the hoses and tubes in a strong, solvent and chemical resistant exterior jacket to prevent loose line failures encountered in competitive options

### Better Hose and Tubing Management

- Cattracks, cable trays and other hose routing stay neater and cleaner as opposed to the normal accumulation of overspray onto all loose lines and the housekeeping mess that is created from using loose lines in the spray area

### More Compact Routing

- More lines per square inch can be provided in cattrack, cable trays or hose ducts so these devices could be downsized to enhance booth air flow or lower costs



## Piggable Hoses and Bundles

Part Number	Description
HOA-43795	Piggable hose, tri-layer, 22MM OD X 12MM ID Polyurethane/FEP tubing, 1000 Ft. Reels maximum length
HOA-43796	Piggable hose, tri-layer, 14MM OD X 8MM ID Polyurethane/FEP tubing, 1000 Ft. Reels maximum length
HOA-43797	Piggable hose bundle, tri-layer 14MM OD X 8MM ID Polyurethane/FEP pig line, (2) FEP-0604, (1) NHA-375275R, (2) NHA-4x2.7 Pilot Lines, 250 foot Reel

For application engineering a custom bundle for your application:

**Email** [customerservice@hosco.net](mailto:customerservice@hosco.net)

**Call** (248) 912-1750.

## Pneumatic/Pilot Bundles

Part Number	Description
HOA-18862	Hose Bundle: (4) NHA-532322 Natural lines marked CP-1 thru CP-4
HOA-18317	Hose Bundle: (6) NHA-532322 Natural lines marked CP-1 thru CP-6
HOA-42146	Hose Bundle: (8) NHA-532332 Natural lines marked CP1-CP8
HOA-43282	Hose Bundle: (9) NHA-532332 Natural Lines marked CP-1-CP-9
HOA-42769	Hose Bundle: (12) NHA-0302 Natural Lines marked CP-1 thru CP-12

## Other Bundles

Part Number	Description
HOA-45970	PVC jacketed bundle with (10) PHA-532332 tubes Custom Colors
HOA-43638	Twinline polyurethane red 5/32 OD X .075" ID, blue 1/4 OD X .125" ID

# Hose Management – Cat Track Assembly

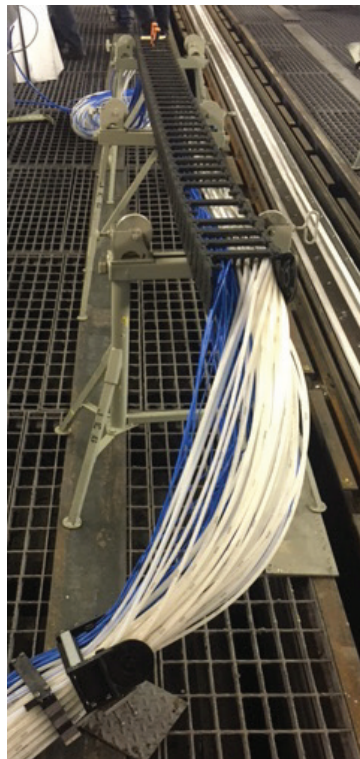
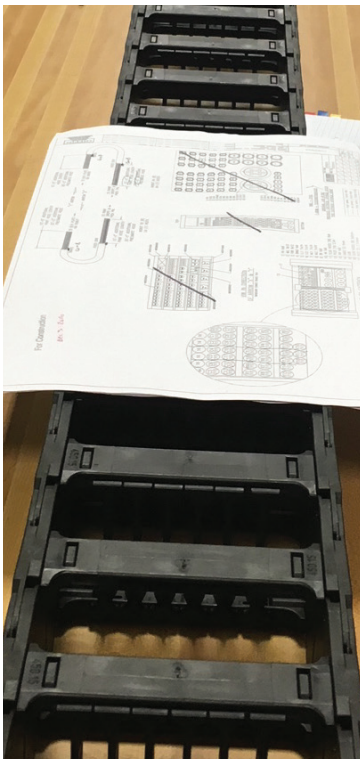

In addition to bundled tubing and assemblies for hose management, Hosco is a certified reseller of Gortrac and IGUS cattracks, allowing for a complete cattrack assembly for replaced or rebuilt robotic stations. Hosco has worked with some of the world's leading integrators and OEMs to assemble and deliver complete cat tracks, cable trays, ducting systems, machine and handgun stations to the job site. Working with our customer's requirements, each hose or tube can be labeled and outfitted with Hosco hose fittings to make for an easy, plug-in-ready installation at the job site.

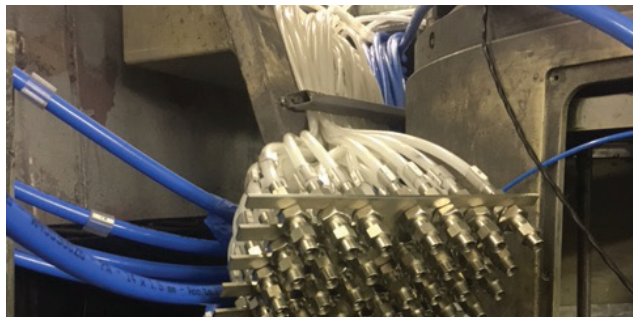



## Hose and Tube Puller Kit



Part Number	Description
CKIDHSP	Hose and Tube Puller Kit*

\* Kit includes one tool of each size listed below, a hose and tubing cutter, and 250' of twine, all in a compact tool box.

Included Tool Sizes
9MM ID x 9MM ID
9MM ID x 8MM ID
9MM ID x 7MM ID
9MM ID x 6MM ID
8MM ID x 8MM ID
8MM ID x 7MM ID
8MM ID x 6MM ID
7MM ID x 7MM ID
7MM ID x 6MM ID
6MM ID x 6MM ID
6MM ID x 4MM ID
3/8" ID x 3/8" ID
3/8" ID x 1/4" ID
1/4" ID x 1/4 ID
1/4" ID x 3/16" ID
3/16" ID x 3/16" ID

Other sizes available, please define size and type of hose or tubing, and quantity required for a quote.

The Hosco hose and tubing puller kit is designed to pull hose and tube through cat tracks and cable tray. Maintenance staff, Pipefitters, Robot Operators can easily add or replace damaged hoses using this tool kit. The kit includes most common metric or fractional inch hose and tubing sizes with an engineered barb to hold during the toughest situations. The outside diameter of the fitting matches that of the hose being pulled to eliminate hang-ups while pulling. A hole is designed into the center of the tool to allow for pulling existing lines without replacement. Twine and a hose cutter are also included in a handy toolbox to complete this kit.

### Feature and Benefits

#### Smooth Barrel Design

- Eliminate hang-ups and pull the replacement hose easier, saving time and effort

#### Stainless Steel Construction

- Strong tool with high hose retention will not wear out through uses

#### Multiple Sizes Available

- Versatile tool for all cattrack or cabletray / duct pulls regardless of the size of the old vs new hose

#### Engineered Barb

- Large hold strength for the bends and long pulls, eliminating multiple tries

### Individual Parts

Straight



Reducing



## Swivel Nut Extension Tool

Part Number	Description
38SN-EXT	Swivel Nut Extension Tool



The new 38SN-EXT tool was developed to assist installers in the connection of any 3/8" NPS(F) swivel nut fitting or hose connector to a 3/8" NPS(M) connection point. Paint station designs are more compact and more densely packed at the booth side that creates problems of access to the connection points. This tool alleviates the need to get your hand into the area and attempt to turn a wrench to complete the connection. With the 38SN-EXT the connection can be made with the 12-16" ratchet style extension tool to move your installation activity away from the confluence of hoses.

To use this tool, place the stationary 7/8" hex body on the ball valve end you are connecting to, and then nest the hose and hose connection into the internal socket and drive it down to the connection point. Using a customer supplied 1/2" ratchet, tighten the hose connector while stabilizing the ball valve outer housing to prevent rotating the ball valve during hose connector installation. Generally tighten to 30-35 ft/lbs to insure long term leak free connection.

# Shroud Cleaner Upgrades and Remote-Mount Regulator Kit

SILICONE  
CERTIFIED  
FREE

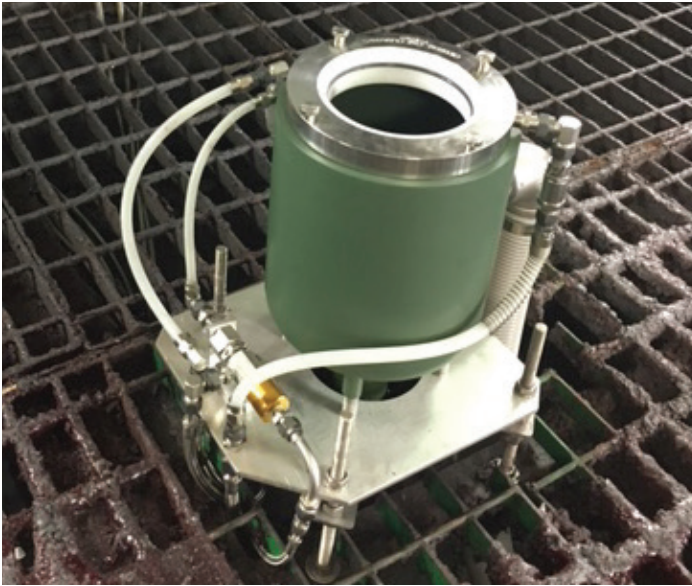

Shroud cleaners in any coating application can be a primary source of “dirt” and surface defects if not properly and continuously maintained, which stems from increasing production and manpower demands.

Hosco has engineered a solution to reduce the maintenance schedule and eliminate many of those defects, freeing up maintenance staff to focus on other issues.

## Common Issues

### Paint Build-up, Inside and Out

• Hosco Solution:

Conductive PTFE (Teflon™) coating reduces frequency of cleaning and disassembly

### Plugged Drains

• Hosco Solution:

Enlarge and relocate drain to most appropriate position based on shroud cleaner model

### Excessive Solvent Pressure

Can flood applicator and shroud, preventing adequate drying and allowing contaminants to force behind and around the shroud and bell cup

• Hosco Solutions:

Regulate pressure to the cap cleaner to ensure level is within shroud cleaner specifications

Assembly for deadheaded or systems with circulating heated solvent

### Difficult to Monitor and Maintain

• Hosco Solutions:

Remote mount regulator outside of booth to access and monitor with ease

Quick disconnect kit for the air ring, easing serviceability



Hosco will work with your engineers or maintenance staff to customize a solution to meet your needs for your particular application and shroud cleaner.

## Spits Per Shift

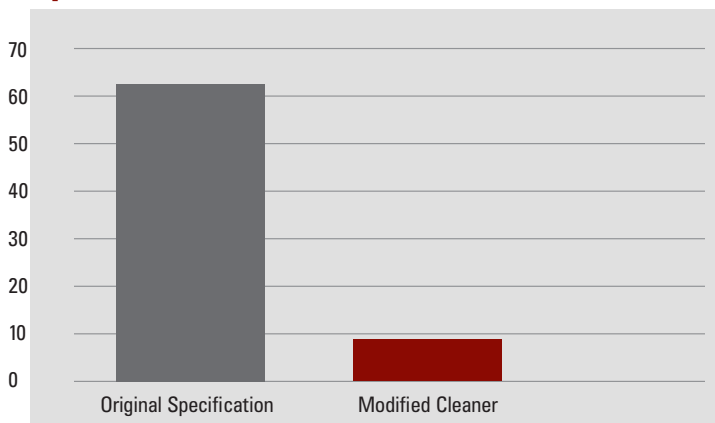

This data is an example of OEM verified quality improvement data due to our Cap Cleaner upgrade program.

# Eliminating the Dirty Applicator

SILICONE  
CERTIFIED  
FREE



Outside of Dirty Applicator Cleaner

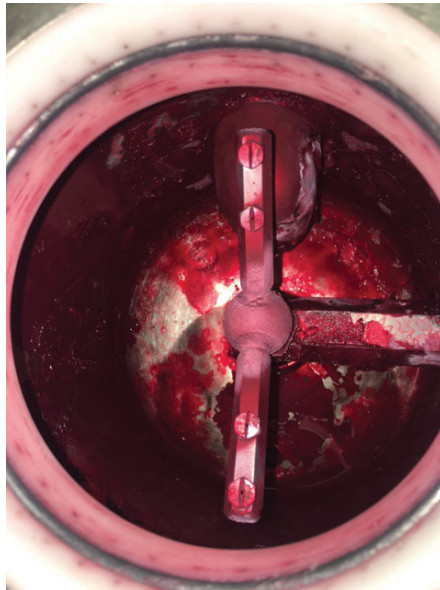

Inside of Dirty Applicator Cleaner

## Known weak points in existing system installations:

As spray defects are analyzed in the Paint Shop Operations, it's often found that the spray gun bell washers are identified as a source of these defects, which may vary in size and severity.

Below are some of the problems from an applicator cleaner installation and/or operation generally ranked on product quality impact from least complicated/serious to the most complicated/serious.

### Problems due to a dirty applicator:

- 1. E-stat faults** – E-stat faults occur when a drips or build-up on a dirty applicator causes a short in the spray operation.
- 2. Mist from cleaner operation** – Small droplets of paint, waste paint or solvent are splashed onto the product or form a mist which settles onto the product due to the turbulent cleaning operation and proximity of the vessel to the product being painted.
- 3. Solvent drips on product** – Generally caused by insufficient blow off during the exiting of the cleaning station, plugged drains contributing to the excessive fluid within the collection vessel, or overfeeding solvent during the wash.
- 4. Dirt in paint** – Particles of dried paint fall into the wet film during the spraying step between cleaning periods in non-catalyzed material spray operations
- 5. Poor paint application** – If a dirty applicator does not cause a fault, uneven paint build-up or streaking may result.

## Hosco Solutions

Hosco is a recognized solutions provider with proven results when it comes to removing defects associated with a dirty applicator. Hosco has been involved in applicator cleaning projects with a few robot stations to entire high-volume plants. A project eliminating the repair/rework of spray defects plus maintenance of the cleaning stations has created enormous savings for plants on an annual basis. With a large cost savings range between project types, all users can benefit from an optimized solution.

Hosco works with many major manufacturers of applicator cleaners in North America and can supply optimized applicator cleaners to insure fast, efficient, and complete cleaning of the applicator. No matter how small or large your operations, you want to reduce spray defects and minimize time and attention required to your cleaners.

## Why do you clean the applicator?

Operators of automated Paint Shops know that problems come from a dirty or wet applicator in proximity to the products being sprayed, especially horizontal surfaces. The purpose of cleaning the applicator is to remove those potential defects by cleaning the exterior and fully drying it at predetermined intervals while the automation is idle between jobs. These intervals can be set by a trained operator, and some of the factors to be considered in setting these are:

- The color change demands. Some colors or materials will require more frequent cleaning intervals, or the user may want to automatically clean the applicator in a change from one color to another depending on past experiences.
- Conductivity of the material being sprayed and electrostatic “wrap” are two major factors that affect this determination of cleaning intervals.
- Solids content and the material’s propensity to coagulate or agglomerate into larger particle sizes.
- Facilities and process factors such as environmental (humidity for example), mechanical (booth air flow, spray pressures/flow-rates, material temperatures (paint & solvent, etc.)

## What do you need to do to optimize performance of the applicator cleaner?

### Air and solvent pressure and flowrate controls

Regardless of the brand or model of the applicator cleaner, air and solvent dispense pressure and flowrate controls are a principal factor in the performance. Both pressures and flowrate must be controlled to manufacturers specifications and ensured that they are consistent. *Too high or too low of either pressure or flowrate will result in inefficiencies and ultimately spray defects.*

### Air & Solvent dispensing temperatures

Using elevated temperature cleaning solvents (waterborne) and drying air can significantly increase cleaning performance and potentially reduce solvent and compressed air usage and time in the cleaning step. Hosco recommends using elevated temperatures up to 130 F for both the waterborne solvent fluid and drying air for the most efficient and effective cleaning.

### Routine Maintenance of the Cleaning Stations

The applicator cleaners must also be disassembled for thorough cleaning of the internals. The frequency of this cleaning is highly dependent on the specific materials running through the cleaner, the environment or location of the cleaner, and it’s use rate.

*A poorly set up and maintained applicator cleaner will cause as many defects as it prevents.*

**While not directly affecting the painting process, maintenance support of the applicator cleaner station is necessary.**

**It is important to set up the frequency of automatic cleaning properly to prevent overloading the cleaning station’s ability to properly clean the applicator, and to provide proper drain timing of the purge fluids in these short durations of cleaning operation.**

**If your experiences with these systems leaves you searching for improvement of these important secondary or sub-system equipment operations noted above, or if you are not an automatic station equipment user of an applicator cleaner, please consult with your Hosco representative to get an assessment of possible improvements.**

# Eliminating the Dirty Applicator

SILICONE  
CERTIFIED  
FREE

## How do you maximize effectiveness of the applicator cleaner and minimize maintenance?

The following steps of performance improvements for these applicator cleaners is summarized into logical feature areas with descriptions.

### Conductive PTFE Coating:

- Reduces the cleaning and disassembly frequency by improving the internal and external surfaces to shed overspray, splashes, and ultimately waste sticking and drying onto those surfaces. It is important due to safety regulations to insure the coating applied is conductive to minimize electrical risks in the spray zone.

### Drain Modifications:

- Enlarge and relocate drains for venting and quick removal of purge material during the cleaning or color change operation. Hosco recommends a 2" NPT port at the lowest section of the collection tank with couplings for easy make and break access during inspection and maintenance.

### Using Solvent Supply Recirculation with Heat applied to the Flush Solvent:

- Hosco recommends elevated temperature flush solvents (manufacturer specific) for waterborne purge materials (i.e. deionized water with amine) to facilitate the cleaning cycle and minimize the time and solvent used in this cleaning operation.

### Using Fluid Pressure and Fluid Flowrate control at the Cleaning station:

- The supply pressure of the cleaning station should not exceed the manufacturer's specifications to prevent migration of solvent fluid into applicator areas that are not protected or could be harmed by the cleaning solvent.
- The supply volume of cleaning solvent should not exceed the manufacturer's specified flowrates at any time during the spraying or wash down of the applicator and should be run at the lowest flowrate possible to perform cleaning.
- With two main options of supplying solvent to the applicator cleaner, both of which depend on purge material and temperature required, Hosco has developed a kit to enable monitoring of solvent pressure at the bulkhead wall.
- Waterborne heated purge material will require circulation at the point of use (applicator cleaner) due to minimal amount of solvent used during a typical cycle when optimized.

### Tool-less Drying ring QD:

- Hosco supplies Cleaning Station equipment (Crystal Cap Cleaner only) with drying rings that require no tools for removal and swap out, making for quick and easy changeout with no special skills or tools required. This includes solvent fluid and drying air Quick Disconnects, and knurled knobs to remove and retain the drying ring.

### Conductive PTFE Coating:



### Drain Modifications:

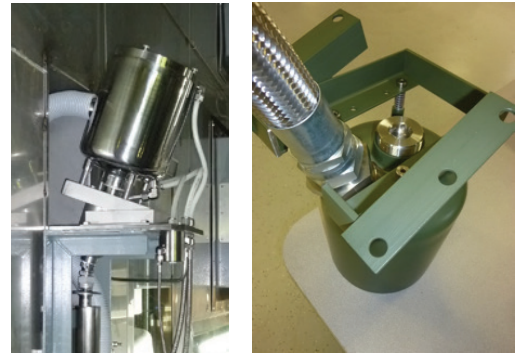

### Supply Recirculation Monoline Coaxial Hose Assembly:



### Using Fluid Pressure and Fluid Flowrate control at the Cleaning station:



# Imaging - Hosco Style

**The Unique Blend of Imagination and Engineering.** Hosco prides itself in its core values to listen and learn from the marketplace and customers, and many of our products were born from ideas or solutions to problems that were started by our customers.

As shown below, many of the challenges we have faced and overcome in the paint handling and paint circulation arena were started by a customer asking us, "What if we do it this way?" or "Can you make something like this?"

We perpetually simplify and streamline product configurations to provide larger solution modules or assemblies that benefit the customer through faster installation, improved performance, longer life or reduced support or maintenance requirements.

Please accept our invitation to challenge us or work with us to provide better solutions in our product areas of expertise, which are broadening to include more initiatives in "dirt in paint" and more broadly in elimination of contaminants in the entire painting operations.

**Sometimes great ideas and solutions start on a scrap of paper.**

You can reach us anytime at [orders@hosco.net](mailto:orders@hosco.net).



Bell Washer Optimization Project to reduce spray defects from Bell and increase time between housekeeping and service intervals, plus tool free connections for the blow off ring.



H-Valve panel to supply two robots from a single paint station drop, bulkhead plate mounted and delivered as a single module for installation.



Hosco PA series of non-conductive hose connectors for ungrounded or electrostatic spray applications delivers the highest level of safety and hose retention performance.



Pre-Constructed, cleaned and ready to install Restrictor Station to simulate pressure loss in an active station to keep the flow and pressure in balance in a paint circulation system.

# Global Reach

Hosco is a finishing system components manufacturer serving the finishing industry worldwide through systems integrators, and an extensive network of regional authorized distributors and agents.

Hosco offers standardized capability for circulation systems and application finishing on a global basis while being the only supplier of both inch and metric smooth-bore, cavity free and microfinished valves and fittings designed specifically for paint.

All Hosco products are certified "silicone free" and ready for installation in your paint systems.

Hosco stands ready with the products, the service, and the expertise to deliver clean, contaminate-free paints and coatings... **whether you are located next door or on the other side of the world.**

**At Hosco we think globally but act locally.**

## Common Paint System Connections

Part Number				
Male	Female	Size	Type	Description
2T	2T(F)	1/8	NPT	National Pipe Taper
4T	4T(F)	1/4	NPT	National Pipe Taper
6T	6T(F)	3/8	NPT	National Pipe Taper
8T	8T(F)	1/2	NPT	National Pipe Taper
2BT	2BT(F)	1/8	BSPT	British Standard Pipe Taper
4BT	4BT(F)	1/4	BSPT	British Standard Pipe Taper
6BT	6BT(F)	3/8	BSPT	British Standard Pipe Taper
4	4SN	1/4	NPS	National Pipe Straight
6	6SN	3/8	NPS	National Pipe Straight
4B	4SNB	1/4	BSP	British Standard Pipe
6B	6SNB	3/8	BSP	British Standard Pipe
4RB	4SN	1/4	RB	Nps Reverse Bulkhead
6RB	6SN	3/8	RB	Nps Reverse Bulkhead
4RBB	4SNB	1/4	RBB	Bsp Reverse Bulkhead
6RBB	6SNB	3/8	RBB	Bsp Reverse Bulkhead
2TUBE	2TF	1/8	Tube	Tube Compression
4TUBE	4TF	1/4	Tube	Tube Compression
6TUBE	6TF	3/8	Tube	Tube Compression
8TUBE	8TF	1/2	Tube	Tube Compression
10MMTUBE	10MMTF	10MM	Tube	Tube Compression
12MMTUBE	12MMTF	12MM	Tube	Tube Compression
4TUBE	4BTF	1/4	Bulkhead	Bulkhead Tube Compression
6TUBE	6BTF	3/8	Bulkhead	Bulkhead Tube Compression
8TUBE	8BTF	1/2	Bulkhead	Bulkhead Tube Compression
10MMTUBE	10MMBTF	10MM	Bulkhead	Bulkhead Tube Compression
12MMTUBE	12MMBTF	12MM	Bulkhead	Bulkhead Tube Compression

## Hosco Affiliates

### Integrated Dispense Solutions

A Detroit based company formed in 2014 that specializes in the precision dispensing of single or multiple fluid components. Systems provide precise, automated dispensing for Adhesive, Sealer, Mastic, Foam, Epoxy, NVH, and materials, from very low flowrates to very high continuous flow ranges.



### Classic Precision

A Detroit based company (AS-9100 Registered) in business since 1990 specializing in machining Super-Alloy components for the Aerospace Industry. Components include fluid & fuel delivery nozzles for turbine engine and propulsion systems, machined from exotic materials like Hastelloy, Inconel, Monel, Stellite, Waspaloy, Stainless Steel and many other exotic alloys.



28026 Oakland Oaks Court  
Wixom, MI 48393

(248) 912-1750  
855 GO HOSCO (855-464-6726)  
Fax: (248)912-1751

www.hosco.net  
Questions: info@hosco.net  
Orders: orders@hosco.net

All Hosco products listed in this catalog are registered under:  
ISO-90021:2008 Certificate No. 0035961  
Canadian Registration No. OC19790.5, expiring November 9, 2027